

Wheel Service Products

Impact Sockets | Socket Sets | Wheel Torque Products
Wheel Centering Products | Wheel & Rim Dismounting Tools
Wheel Attaching Hardware | Tire & Wheel Service Tools



➔ 1/2" DR Impact Socket Sets



Impact Socket Sets

WHEEL SERVICE PRODUCTS // IMPACT SOCKETS

1/2" DR 13-PIECE SAE SET

▪ **INCLUDES THE FOLLOWING SIZES:**
7/16", 1/2", 9/16", 5/8", 11/16",
3/4", 13/16", 7/8", 15/16",
1", 1-1/16", 1-1/8", 1-1/4"

ASCOT NO.	MFG. NO.	DESCRIPTION
163-01150	1150	1/2" DR 13-Piece SAE Set



163-01150

1/2" DR 13-PIECE DEEP SET

▪ **INCLUDES THE FOLLOWING SIZES:**
7/16", 1/2", 9/16", 5/8", 11/16", 3/4", 13/16",
7/8", 15/16", 1", 1-1/16", 1-1/8", 1-1/4"

ASCOT NO.	MFG. NO.	DESCRIPTION
163-01151	1151D	1/2" DR 13-Piece Deep Set



163-01151

1/2" DR 14-PIECE METRIC STANDARD SET

▪ **INCLUDES THE FOLLOWING SIZES:** 10mm, 11mm, 12mm,
13mm, 14mm, 15mm, 16mm,
17mm, 18mm, 19mm, 21mm,
22mm, 26mm, 27mm

ASCOT NO.	MFG. NO.	DESCRIPTION
163-01152	1152M	1/2" DR 14-Piece Metric Standard Set



163-01152

1/2" DR 14-PIECE METRIC DEEP SET

▪ **INCLUDES THE FOLLOWING SIZES:**
10mm, 11mm, 12mm, 13mm, 14mm,
15mm, 16mm, 17mm, 18mm, 19mm,
21mm, 22mm, 26mm, 27mm

ASCOT NO.	MFG. NO.	DESCRIPTION
163-01153	1153MD	1/2" DR 14-Piece Metric Deep Set



163-01153

1/2" DR 29-PIECE METRIC AND SAE 6 POINT DEEP IMPACT SOCKET SET

▪ **INCLUDES THE FOLLOWING SIZES:** 7/16", 1/2", 9/16",
5/8", 11/16", 3/4", 13/16",
7/8", 15/16", 1", 1-1/16", 1-1/8"
and 1-1/4" deep sockets ▪ 10, 11,
12, 13, 14, 15, 16, 17, 18, 19, 21, 22, 26
and 27mm deep sockets ▪ 3/4" x 13/16"
deep and 19mm x 21mm deep flip sockets

ASCOT NO.	MFG. NO.	DESCRIPTION
163-05153	1153DD	1/2" DR 29-Piece Metric and SAE 6 Point Deep Impact Socket Set



163-05153

1/2" DR 5-PIECE DEEP THIN WALL FLIP SET

▪ **INCLUDES THE FOLLOWING SIZES:** 3/4" x 13/16", 19mm x
21mm, 7/8" x 15/16", 17mm
x 19mm, 3" extension

ASCOT NO.	MFG. NO.	DESCRIPTION
167-12050	1205D	1/2" DR 5-Piece Deep Thin Wall Flip Set



167-12050

3/4" DR 10-PIECE TRUCK SET

▪ **INCLUDES THE FOLLOWING SIZES:**
13/16" Square Socket, 1-1/16", 1-1/8",
1-1/4" Thin Wall Deep Sockets, 1-1/2"
Budd Wheel Socket, 17mm & 21mm
Square Socket, 33mm, 35mm
& 41mm Deep Sockets

ASCOT NO.	MFG. NO.	DESCRIPTION
164-02110	2110	3/4" DR 10-Piece Truck Set



164-02110

3/4" DR 8-PIECE SAE DEEP SET

▪ **INCLUDES THE FOLLOWING SIZES:** 1", 1-1/16", 1-1/8", 1-1/4",
1-5/16", 1-3/8", 1-7/16", 1-1/2"

ASCOT NO.	MFG. NO.	DESCRIPTION
164-02181	2181D	3/4" DR 8-Piece SAE Deep Set



164-02181

Easier to identify and find right impact socket with new & improved laser etching!





➔ 1/2" DR, 3/4" DR, 1" DR Impact Socket Sets

3/4" DR 5-PIECE METRIC STANDARD TRUCK SET

▪ **INCLUDES THE FOLLOWING SIZES:** 4 pts. budd wheel standard length, 17mm, 27mm, 30mm, 33mm, 35mm standard



ASCOT NO.	MFG. NO.	DESCRIPTION
164-02185	2185M	3/4" DR 5-Piece Metric Standard Truck Set

164-02185

1" DR 9-PIECE OTR & TRUCK SOCKET SET

▪ **INCLUDES THE FOLLOWING SIZES:** 13/16" & 15/16" square, 33mm, 1-1/2", 1-5/8", 1-3/4", 1-7/8", 2" & 2-1/2" deep sockets



ASCOT NO.	MFG. NO.	DESCRIPTION
165-03119	3119	1" DR 9-Piece Large Truck Socket Set

165-03119

3/4" DR 4-PIECE BUDD WHEEL SOCKET SET

▪ **INCLUDES THE FOLLOWING SIZES:** 1-1/2" hex x 13/16" square budd wheel impact socket, 35mm x 17mm square budd wheel impact socket, 41mm x 21mm square budd wheel impact socket and 33mm deep



ASCOT NO.	MFG. NO.	DESCRIPTION
164-04626	4626	3/4" DR 4-Piece Budd Wheel Socket Set

164-04626

1" DR 10-PIECE TRUCK SET

▪ **INCLUDES THE FOLLOWING SIZES:** 13/16" square, 1-1/16", 1-1/8", 1-1/4" thin wall deep, 1-1/2" deep with inside lip, 17mm & 21mm square with inside lip, 33mm, 35mm & 41mm deep



ASCOT NO.	MFG. NO.	DESCRIPTION
165-03110	3110	1" DR 10-Piece Truck Set

165-03110

1" DR 5-PIECE BUDD WHEEL SOCKET SET

▪ **INCLUDES THE FOLLOWING SIZES:** 1-1/2" hex x 13/16" square budd wheel impact socket, 35mm x 17mm square budd wheel impact socket, 38mm x 20mm square budd wheel impact socket, 41mm x 21mm square budd wheel impact socket and 33mm deep impact socket



ASCOT NO.	MFG. NO.	DESCRIPTION
165-05626	5626	1" DR 5-Piece Budd Wheel Socket Set

165-05626

1" DR 9-PIECE SAE TRUCK SET

▪ **INCLUDES THE FOLLOWING SIZES:** 13/16", 4 points budd wheel standard length, 7/8", 15/16", 1", 1-3/16", 1-1/2" deep with inside lip, 1-1/16", 1-1/8", 1-1/4" thin wall deep



ASCOT NO.	MFG. NO.	DESCRIPTION
165-03190	3190	1" DR 9-Piece SAE Truck Set

165-03190

1" DR 7-PIECE METRIC TRUCK SET

▪ **INCLUDES THE FOLLOWING SIZES:** 17mm, 21mm, 4 pts. budd wheel standard length, 27mm, 33mm, 36mm, 41mm deep



ASCOT NO.	MFG. NO.	DESCRIPTION
165-03197	3197M	1" DR 7-Piece Metric Truck Set

165-03197

Please call us for more detailed information regarding our **SOCKET SETS**.

WHEEL SERVICE PRODUCTS // IMPACT SOCKETS



Impact Socket Sets (cont.)

#5 SPLINE DR 9-PIECE SAE TRUCK SET

▪ **INCLUDES THE FOLLOWING SIZES:** 13/16", 4 points budd wheel standard length, 7/8", 15/16", 1", 1-3/16", 1-1/2" deep with inside lip, 1-1/16", 1-1/8", 1-1/4" thin wall deep



166-04191

ASCOT NO.	MFG. NO.	DESCRIPTION
166-04191	4191	#5 Spline DR 9-Piece SAE Truck Set

1/2" DR 3-PIECE FLIP IMPACT SOCKET SET

▪ **CR-MO steel for long life** ▪ Fully guaranteed ▪ Heavy duty blow mold case ▪ **CONTAINS THE FOLLOWING SIZES:** 3/4" x 13/16" - 1246DT, 19mm x 21mm - 1291DT



167-12030

ASCOT NO.	MFG. NO.	DESCRIPTION
167-12030	1203D	1/2" Drive 3-Piece Flip Impact Socket Set

4-PIECE IMPACT ADAPTER SOCKET SET

▪ **CR-MO steel for long life** ▪ Heavy duty blow mold case ▪ **CONTAINS THE FOLLOWING SIZES:** 1/2" (F) x 3/4" (M) adapter, 3/4" (F) x 1" (M) adapter, 3/4" (F) x 1/2" (M) adapter, 1" (F) x 3/4" (M) adapter



169-01234

ASCOT NO.	MFG. NO.	DESCRIPTION
169-01234	1234A	4-Piece Impact Adapter Socket Set

5-PIECE 1/2" DR TWIST SOCKET SET

▪ **Designed to easily remove damaged, rounded nuts** ▪ CR-MO steel for long life ▪ Use with 1/2" drive impact wrench or breaker bar ▪ Heavy duty blow molded case ▪ **INCLUDES:** 17mm, 19mm, 21mm & 22mm twist sockets plus a 50mm extractor punch



492-00502

ASCOT NO.	MFG. NO.	DESCRIPTION
492-00502	TSS5	5-Piece 1/2" Drive Twist Socket Set



➔ 1/2" DR Impact Socket Sets, 1/2" DR Wheel Protector Socket Set

1/2" DR MASTER 39-PIECE SAE IMPACT SOCKET SET

- **CR-MO alloy steel for long life** ▪ Fully guaranteed
- Heavy duty blow mold case ▪ **19 STANDARD SOCKETS:** 3/8", 7/16", 1/2", 9/16", 5/8", 11/16", 3/4", 13/16", 7/8", 15/16", 1", 1-1/16", 1-1/8", 1-3/16", 1-1/4", 1-5/16", 1-3/8", 1-7/16" and 1-1/2" ▪ **19 DEEP SOCKETS:** 3/8", 7/16", 1/2", 9/16", 5/8", 11/16", 3/4", 13/16", 7/8", 15/16", 1", 1-1/16", 1-1/8", 1-3/16", 1-1/4", 1-5/16", 1-3/8", 1-7/16" and 1-1/2" Universal



CR-MO ALLOY STEEL FOR LONG LIFE

163-02668

ASCOT NO.	MFG. NO.	DESCRIPTION
163-02668	2668	1/2" DR Master 39-Piece SAE Impact Socket Set

1/2" DR MASTER 39-PIECE METRIC IMPACT SOCKET SET

- **CR-MO alloy steel for long life** ▪ Fully guaranteed
- Heavy duty blow mold case ▪ **19 STANDARD SOCKETS:** 9mm, 10mm, 11mm, 12mm, 13mm, 14mm, 15mm, 16mm, 17mm, 18mm, 19mm, 20mm, 21mm, 22mm, 23mm, 24mm, 26mm, 27mm and 30mm ▪ **19 DEEP SOCKETS:** 9mm, 10mm, 11mm, 12mm, 13mm, 14mm, 15mm, 16mm, 17mm, 18mm, 19mm, 20mm, 21mm, 22mm, 23mm, 24mm, 26mm, 27mm and 30mm Universal Joint



CR-MO ALLOY STEEL FOR LONG LIFE

163-02669

ASCOT NO.	MFG. NO.	DESCRIPTION
163-02669	2669	1/2" DR Master 39-Piece Metric Impact Socket Set

1/2" DR EXTRA THIN WALL 9-PIECE SAE & METRIC WHEEL PROTECTOR SOCKET SET

- **Durable outer sleeve and insert protects high polished wheels and lug nuts from damage** ▪ CR-MO alloy steel for long life ▪ Fully guaranteed ▪ Heavy duty blow mold case ▪ **INCLUDES 6 SAE SOCKETS:** 3/4" (light green), 13/16" (purple), 7/8" (green), 15/16" (brown), 1" (silver) and 1-1/16" (black) ▪ **INCLUDES 3 METRIC SOCKETS:** 17mm (blue), 19mm (yellow) and 21mm (red)



CR-MO ALLOY STEEL FOR LONG LIFE

DURABLE OUTER SLEEVE & INSERT

163-02849

ASCOT NO.	MFG. NO.	DESCRIPTION
163-02849	2849	1/2" DR Extra Thin Wall 9-Piece SAE & Metric Wheel Protector Socket Set

REPLACEMENT SOCKETS FOR 2849 SET

ASCOT NO.	MFG. NO.	DESCRIPTION
163-28492	28492	1/2"x3/4" Socket
163-28494	28494	1/2"x13/16" Socket
163-28496	28496	1/2"x7/8" Socket
163-28498	28498	1/2"x15/16" Socket
163-28910	284910	1/2"x1" Socket
163-28912	284912	1/2"x1-1/16" Socket
163-28917	284917	1/2"x17mm Socket
163-28919	284919	1/2"x19mm Socket
163-28921	284921	1/2"x21mm Socket

WHEEL SERVICE PRODUCTS // IMPACT SOCKETS



Individual Impact Sockets

WHEEL SERVICE PRODUCTS // IMPACT SOCKETS

1/2" DR STANDARD IMPACT SOCKETS

ASCOT NO.	MFG. NO.	DESCRIPTION
METRIC		
163-10100	1010M	1/2" Drive x 10mm Std.
163-10111	1011M	1/2" Drive x 11mm Std.
163-10120	1012M	1/2" Drive x 12mm Std.
163-10130	1013M	1/2" Drive x 13mm Std.
163-10142	1014M	1/2" Drive x 14mm Std.
163-10150	1015M	1/2" Drive x 15mm Std.
163-10162	1016M	1/2" Drive x 16mm Std.
163-10170	1017M	1/2" Drive x 17mm Std.
163-10182	1018M	1/2" Drive x 18mm Std.
163-10190	1019M	1/2" Drive x 19mm Std.
163-10210	1021M	1/2" Drive x 21mm Std.
163-10221	1022M	1/2" Drive x 22mm Std.
163-10262	1026M	1/2" Drive x 26mm Std.
163-10270	1027M	1/2" Drive x 27mm Std.
SAE		
163-10140	1014	1/2" Drive x 7/16" Std.
163-10160	1016	1/2" Drive x 1/2" Std.
163-10180	1018	1/2" Drive x 9/16" Std.
163-10200	1020	1/2" Drive x 5/8" Std.
163-10220	1022	1/2" Drive x 11/16" Std.
163-10240	1024	1/2" Drive x 3/4" Std.
163-10260	1026	1/2" Drive x 13/16" Std.
163-10280	1028	1/2" Drive x 7/8" Std.
163-01030	1030	1/2" Drive x 15/16" Std.
163-10320	1032	1/2" Drive x 1" Std.
163-10340	1034	1/2" Drive x 1-1/16" Std.
163-10360	1036	1/2" Drive x 1-1/8" Std.
163-10400	1040	1/2" Drive x 1-1/4" Std.

1/2" DR EXTRA THIN WALL IMPACT SOCKETS

ASCOT NO.	MFG. NO.	DESCRIPTION
METRIC		
163-10172	1017MEDT	1/2" Drive x 17mm Extra Thin Wall
163-10191	1019MEDT	1/2" Drive x 19mm Extra Thin Wall
163-10211	1021MEDT	1/2" Drive x 21mm Extra Thin Wall
163-10223	1022MEDT	1/2" Drive x 22mm Extra Thin Wall
163-10230	1023MEDT	1/2" Drive x 23mm Extra Thin Wall
SAE		
163-10241	1024EDT	1/2" Drive x 3/4" Extra Thin Wall
163-10261	1026EDT	1/2" Drive x 13/16" Extra Thin Wall
163-10282	1028EDT	1/2" Drive x 7/8" Extra Thin Wall

ASCOT NO.	MFG. NO.	DESCRIPTION
METRIC		
163-10101	1010MD	1/2" Drive x 10mm Deep
163-10121	1012MD	1/2" Drive x 12mm Deep
163-10131	1013MD	1/2" Drive x 13mm Deep
163-10143	1014MD	1/2" Drive x 14mm Deep
163-10151	1015MD	1/2" Drive x 15mm Deep
163-10163	1016MD	1/2" Drive x 16mm Deep
163-10171	1017MD	1/2" Drive x 17mm Deep
163-01018	1018MD	1/2" Drive x 18mm Deep
163-01019	1019MD	1/2" Drive x 19mm Deep
163-01021	1021MD	1/2" Drive x 21mm Deep
163-10222	1022MD	1/2" Drive x 22mm Deep
163-10263	1026MD	1/2" Drive x 26mm Deep
163-10271	1027MD	1/2" Drive x 27mm Deep
163-10283	1028MD	1/2" Drive x 28mm Deep
163-01032	1032MD	1/2" Drive x 32mm Deep
163-01033	1033MD	1/2" Drive x 33mm Deep
SAE		
163-10141	1014D	1/2" Drive x 7/16" Deep
163-10161	1016D	1/2" Drive x 1/2" Deep
163-10181	1018D	1/2" Drive x 9/16" Deep
163-10201	1020D	1/2" Drive x 5/8" Deep
163-01022	1022D	1/2" Drive x 11/16" Deep
163-01024	1024D	1/2" Drive x 3/4" Deep
163-01026	1026D	1/2" Drive x 13/16" Deep
163-10281	1028D	1/2" Drive x 7/8" Deep
163-10300	1030D	1/2" Drive x 15/16" Deep
163-11032	1032D	1/2" Drive x 1" Deep
163-01034	1034D	1/2" Drive x 1-1/16" Deep
163-01036	1036D	1/2" Drive x 1-1/8" Deep
163-10401	1040D	1/2" Drive x 1-1/4" Deep
163-01048	1048D	1/2" Drive x 1-1/2" Deep
163-15260	1526SD	1/2" Drive x 13/16" Square 8-Point

1/2" DR FLIP IMPACT SOCKETS

ASCOT NO.	MFG. NO.	DESCRIPTION
METRIC		
167-12110	1211D	1/2" Dr. x 11mm x 12mm Chrome Deep Flip
167-12179	1271DT	1/2" Dr. x 17mm x 19mm Deep Thin Flip
167-12910	1291	1/2" Dr. x 19mm x 21mm Std. Flip
167-12911	1291D	1/2" Dr. x 19mm x 21mm Deep Flip
167-12912	1291DT	1/2" Dr. x 19mm x 21mm Deep Extra Thin Flip
SAE		
167-12460	1246D	1/2" Dr. x 3/4" x 13/16" Deep Flip
167-12461	1246DT	1/2" Dr. x 3/4" x 13/16" Deep Extra Thin Flip
167-12490	1249D	1/2" Dr. x 7/8" x 15/16" Deep Flip
167-12510	1251D	1/2" Dr. x 1" x 1-1/16" Deep Flip

Please contact us for further details regarding Individual Impact Sockets





➔ Individual Impact Sockets

ASCOT NO.	MFG. NO.	DESCRIPTION
164-02017	2017MS	3/4" Drive x 17mm Square
164-02019	2019MS	3/4" Drive x 19mm Square
164-02020	2020MS	3/4" Drive x 20mm Square
164-02021	2021MS	3/4" Drive x 21mm Square
164-02024	2024D	3/4" Drive x 3/4" Deep
164-02026	2026S	3/4" Drive x 13/16" Square
164-02028	2028D	3/4" Drive x 7/8" Deep
164-02030	2030	3/4" Drive x 15/16" Std.
164-02032	2032D	3/4" Drive x 1" Deep
164-02033	2033MD	3/4" Drive x 33mm Deep
164-02034	2034DT	3/4" Drive x 1-1/16" Deep Thin Wall
METRIC		
164-20270	2027M	3/4" Drive x 27mm Std.
164-20271	2027MD	3/4" Drive x 27mm Deep
164-20301	2030M	3/4" Drive x 30mm Std.
164-20330	2033M	3/4" Drive x 33mm Std.
164-02035	2035M	3/4" Drive x 35mm Std.
164-20350	2035MD	3/4" Drive x 35mm Deep
164-20360	2036MD	3/4" Drive x 36mm Deep
164-02041	2041MD	3/4" Drive x 41mm Deep
SAE		
164-20260	2026D	3/4" Drive x 13/16" Deep
164-20300	2030D	3/4" Drive x 15/16" Deep
164-02036	2036DT	3/4" Drive x 1-1/8" Deep Thin Wall
164-20401	2040D	3/4" Drive x 1-1/4" Deep
164-20402	2040DT	3/4" Drive x 1-1/4" Deep Thin Wall
164-02038	2038D	3/4" Drive x 1-3/16" Deep
164-02042	2042D	3/4" Drive x 1-5/16" Deep
164-02044	2044D	3/4" Drive x 1-3/8" Deep
164-02046	2046D	3/4" Drive x 1-7/16" Deep
164-20480	2048	3/4" Drive x 1-1/2" Std.
164-20481	2048D	3/4" Drive x 1-1/2" Deep
164-20482	2048DR	3/4" Drive x 1-1/2" Limited Depth
164-02052	2052D	3/4" Drive x 1-5/8" Deep
164-02056	2056D	3/4" Drive x 1-3/4" Deep
164-02060	2060D	3/4" Drive x 1-7/8" Deep
164-02323	2323C	3/4" Drive x 1-1/2" Hex x 13/16" Square

3/4" DR IMPACT SOCKETS

ASCOT NO.	MFG. NO.	DESCRIPTION
METRIC		
166-04033	4033MD	#5 Spline x 33mm Deep
166-04035	4035MDT	#5 Spline x 35mm Deep Thin Wall
166-04041	4041MDT	#5 Spline x 41mm Deep Thin Wall
SAE		
166-04026	4026S	#5 Spline x 13/16" Square
166-04034	4034DT	#5 Spline x 1-1/16" Deep Thin Wall
166-40360	4036D	#5 Spline x 1-1/8" Deep
166-40361	4036DT	#5 Spline x 1-1/8" Deep Thin Wall
166-04038	4038	#5 Spline x 1-3/16" Std.
166-04040	4040DT	#5 Spline x 1-1/4" Deep Thin Wall
166-04042	4042DT	#5 Spline x 1-5/16" Deep Thin Wall
166-04048	4048D	#5 Spline x 1-1/2" Deep w/Inside Lip
166-40480	4048DT	#5 Spline x 1-1/2" Deep Thin Wall
166-04323	4323C	#5 Spline x 13/16" Square x 1-1/2" Hex

#5 SPLINE DR IMPACT SOCKETS

ASCOT NO.	MFG. NO.	DESCRIPTION
METRIC		
165-03017	3017MS	1" Drive x 17mm Square
165-03019	3019MS	1" Drive x 19mm Square
165-03020	3020MS	1" Drive x 20mm Square
165-03021	3021MS	1" Drive x 21mm Square
165-03027	3027MD	1" Drive x 27mm Deep
165-30302	3030MD	1" Drive x 30mm Deep
165-03033	3033MD	1" Drive x 33mm Deep
165-03035	3035MD	1" Drive x 35mm Deep
165-30381	3038MD	1" Drive x 38mm Deep
165-30410	3041MDT	1" Drive x 41mm Deep Thin Wall
165-03041	3041MD	1" Drive x 41mm Deep
165-03321	3321MC	1" Drive 41mm x 21mm Square
165-03517	3517MC	1" Drive x 35mm Deep x 17mm Sq.
165-03820	3820MC	1" Drive x 38mm Deep x 20mm Sq.
SAE		
165-03026	3026S	1" Drive x 13/16" Square
165-03030	3030S	1" Drive x 15/16" Square
165-03034	3034DT	1" Drive x 1-1/16" Thin Wall Deep
165-03042	3042D	1" Drive x 1-5/16" Deep
165-03044	3044D	1" Drive x 1-3/8" Deep
165-03046	3046D	1" Drive x 1-7/16" Deep
165-03052	3052D	1" Drive x 1-5/8" Deep
165-03054	3054D	1" Drive x 1-11/16" Deep
165-03056	3056D	1" Drive x 1-3/4" Deep
165-03060	3060D	1" Drive x 1-7/8" Deep
165-03323	3323C	1" Drive 1-1/2" Hex x 13/16" Square
165-30280	3028	1" Drive x 7/8" Std.
165-30281	3028D	1" Drive x 7/8" Deep
165-30300	3030	1" Drive x 15/16" Std.
165-30301	3030D	1" Drive x 15/16" Deep
165-30320	3032	1" Drive x 1" Std.
165-30321	3032D	1" Drive x 1" Deep
165-30361	3036D	1" Drive x 1-1/8" Deep
165-30362	3036DT	1" Drive x 1-1/8" Deep Thin Wall
165-30380	3038D	1" Drive x 1-3/16" Deep
165-30401	3040D	1" Drive x 1-1/4" Deep
165-30402	3040DT	1" Drive x 1-1/4" Deep Thin Wall
165-30420	3042DT	1" Drive x 1-5/16" Deep Thin Wall
165-30481	3048D	1" Drive x 1-1/2" Deep w/Inside Lip
165-30482	3048DR	1" Drive x 1-1/2" Deep - Standard

1" DR IMPACT SOCKETS

ASCOT NO.	MFG. NO.	DESCRIPTION
169-01002	1002E	1/4" Drive x 2" Chrome Extension
169-01003	1003E	1/2" Drive x 3" Extension
169-01005	1005E	1/2" Drive x 5" Extension
169-01020	1020A	1/2" Drive Female x 3/4" Male Adapt.
169-02006	2006E	3/4" Drive x 6" Extension
169-02010	2010A	3/4" Drive Female x 1/2" Male Adapt.
169-02030	2030A	3/4" Drive Female x 1" Male Adapt.
169-20100	2010E	3/4" Drive x 10" Extension
169-02013	2013E	3/4" Drive x 13" Extension
169-03006	3006E	1" Drive x 6" Extension
169-03010	3010E	1" Drive x 10" Extension
169-03013	3013E	1" Drive x 13" Extension
169-03020	3020A	1" Drive Female x 3/4" Male Adapt.
169-04010	4010A	#5 Spline Female x 3/4" Male Adapt.
169-04020	4020A	#5 Spline Female x 1" Male Adapt.

IMPACT EXTENSIONS & ADAPTERS

WHEEL SERVICE PRODUCTS // IMPACT SOCKETS

→ Torque Sockets, Torque Extensions

Torque Wrenches & Torque Accessories

MEDIUM/HEAVY DUTY TORQUE SOCKETS

- Originally patented AccuTorq[®] sockets properly torque wheel nuts to exact factory specs
- Prevents warping of rotors, which causes brake pulsation
- Eliminates broken studs and nuts
- Avoids damage to aluminum alloy wheels
- Stops customer complaints about over-tightened lug nuts
- Strobe marks stop turning at the CORRECT torque
- Includes heavy duty case



495-04000

ASCOT NO.	MFG. NO.	DESCRIPTION
495-00103	10-0103	AccuTorq [®] Torque Chart
495-03915	20-3915	5-Piece AccuTorq [®] Med. Duty Truck Set. SET INCLUDES: MD Purple, MD Tan, MD Olive, MD Burgundy & HD Orange
495-04000	20-4000	4-Piece AccuTorq [®] 1" DR Heavy Duty Truck Set. SET INCLUDES: HD Red, HD Yellow, HD Brown & HD Black, plus Heavy Duty Case
495-04100	20-4100	4-Piece AccuTorq [®] 3/4" DR Heavy Duty Truck Set. SET INCLUDES: HD Red, HD Yellow, HD Brown & HD Black, plus Heavy Duty Case

ASCOT NO.	MFG. NO.	DESCRIPTION	DRIVE	SIZE	TORQUE	OTHER
MEDIUM/HEAVY DUTY TORQUE SOCKETS: KIT CONTENTS						
495-03045	20-3045	HD Unpainted	1"	30mm	330 Ft./lbs.	
495-03360	20-3360	HD Unpainted	1"	33mm	440 Ft./lbs.	
495-03900	20-3900	MD Purple	1/2"	1"	140 Ft./lbs.	Deep Well
495-03901	20-3901	MD Tan	1/2"	1-1/16"	140 Ft./lbs.	Deep Well
495-03902	20-3902	MD Olive	1/2"	1-1/8"	140 Ft./lbs.	
495-03903	20-3903	MD Burgundy	1/2"	1-1/4"	140 Ft./lbs.	
495-03904	20-3904	HD Orange	3/4"	1"	175 Ft./lbs.	
495-03918	20-3918	HD Red	3/4"	1-1/4"	250 Ft./lbs.	
495-03919	20-3919	HD Brown	3/4"	33mm (1-5/16")	475 Ft./lbs.	
495-03920	20-3920	HD Black	3/4"	1-1/2"	475 Ft./lbs.	
495-03921	20-3921	HD Yellow	3/4"	13/16" Square	475 Ft./lbs.	
495-03908	20-3908	HD Red	1"	1-1/4"	250 Ft./lbs.	
495-03909	20-3909	HD Brown	1"	33mm (1-5/16")	475 Ft./lbs.	
495-03910	20-3910	HD Black	1"	1-1/2"	475 Ft./lbs.	
495-03911	20-3911	HD Yellow	1"	13/16" Square	475 Ft./lbs.	

HEAVY DUTY TRUCK TORQUE EXTENSIONS



- Heavy duty truck extensions can convert sockets into Torque Sockets
- Available in 3/4" and 1" drives



Heavy Duty Truck Torque Extensions

ASCOT NO.	MFG. NO.	DESCRIPTION
495-16000	1600-M	3/4" Dr. Truck Torque Extension - 475 Ft./lbs.
495-16001	1600-N	3/4" Dr. Truck Torque Extension - 250 Ft./lbs.
495-16002	1600-Q	3/4" Dr. Truck Torque Extension - 175 Ft./lbs.
495-16003	1600-U	3/4" Dr. Truck Torque Extension - 350 Ft./lbs.
495-16014	1600-P	1" Drive Truck Torque Extension - 475 Ft./lbs.
495-16015	1600-R	1" Drive Truck Torque Extension - 250 Ft./lbs.
495-16016	1600-S	1" Drive Truck Torque Extension - 350 Ft./lbs.
495-16017	1600-T	1" Drive Truck Torque Extension - 175 Ft./lbs.

3/4" X 1" X 13" TORQUE WRENCH EXTENSION



169-13413

ASCOT NO.	MFG. NO.	DESCRIPTION
169-13413	13413E	3/4" Dr. x 1" Dr. x 13" Impact Extension
168-12997	12297	3/4" Drive Block for Flex Hinge Torque Wrench
168-12999	12299	1" Drive Block for Flex Hinge Torque Wrench

WHEEL SERVICE PRODUCTS // WHEEL TORQUE PRODUCTS

➔ Torque Sockets, Torque Limiting Socket Set



PASSENGER CAR AND LIGHT TRUCK TORQUE SOCKETS

- Originally patented AccuTorq sockets properly torque wheel nuts to exact factory specs
- Prevents warping of rotors, which causes brake pulsation
- Eliminates broken studs and nuts
- Avoids damage to aluminum alloy wheels
- Stops customer complaints about over-tightened lug nuts
- Strobe marks stop turning at the CORRECT torque



495-00322

ASCOT NO.	MFG. NO.	DESCRIPTION
495-00315	10-0315	4-Piece AccuTorq Automotive Set. SET INCLUDES: Gray, Brown, Blue, & Yellow
495-00321	10-0321	8-Piece AccuTorq Auto & Mini Van Set. SET INCLUDES: Yellow, Red, Blue, Brown, Green, Lt. Brown, Gray & Turquoise
495-00322	10-0322	10-Piece AccuTorq Auto & Lt. Truck Set. SET INCLUDES: Yellow, Red, Blue, Brown, Green, Lt. Brown, Gray, Turquoise, White & Lt. Green
495-00450	10-0450	4-Piece AccuTorq Lt. Truck Set. SET INCLUDES: White, Turquoise, Lt. Green & Charcoal
495-00455	10-0455	5-Piece AccuTorq Lt. Truck Set. SET INCLUDES: White, Turquoise, Lt. Green, Charcoal & Lt. Purple

ASCOT NO.	MFG. NO.	DESC.	DRIVE	SIZE	TORQUE	OTHER
PASSENGER CAR & LIGHT TRUCK TORQUE SOCKETS: KIT CONTENTS						
495-00304	10-0304	Green	1/2"	17mm	55 Ft./lbs.	
495-00305	10-0305	Red	1/2"	17mm	80 Ft./lbs.	
495-00306	10-0306	Yellow	1/2"	19mm (3/4")	65 Ft./lbs.	Deep Well
495-00307	10-0307	Blue	1/2"	19mm (3/4")	80 Ft./lbs.	Deep Well
495-00308	10-0308	Gray	1/2"	19mm (3/4")	100 Ft./lbs.	
495-00309	10-0309	Black	1/2"	21mm	60 Ft./lbs.	
495-00310	10-0310	Lt. Brown	1/2"	21mm	80 Ft./lbs.	
495-00311	10-0311	Brown	1/2"	21mm (13/16")	100 Ft./lbs.	
495-00312	10-0312	White	1/2"	22mm	120 Ft./lbs.	Deep Well
495-00313	10-0313	Turquoise	1/2"	22mm	140 Ft./lbs.	Deep Well
495-00327	10-0327	Lt. Blue	1/2"	22mm	100 Ft./lbs.	
495-00328	10-0328	Charcoal	1/2"	21mm	147 Ft./lbs.	Deep Well
495-00329	10-0329	Off White	1/2"	17mm	90 Ft./lbs.	
495-00334	10-0334	Lt. Yellow	1/2"	17mm	113 Ft./lbs.	
495-00336	10-0336	Orange	1/2"	22mm	75 Ft./lbs.	
495-00337	10-0337	Dark Green	1/2"	22mm	60 Ft./lbs.	
495-03898	10-3898	Lt. Purple	1/2"	21mm	160 Ft./lbs.	Deep Well
495-03899	10-3899	Lt. Green	1/2"	24mm (15/16")	140 Ft./lbs.	Deep Well



10-PIECE 1/2" DRIVE TORQUE LIMITING SOCKET SET

- Contains the most popular torque sockets to service the majority of passenger cars and light trucks
- **SET INCLUDES:** All 10 torque sockets listed below
- Lifetime warranty
- Heavy duty blow molded case
- Lug nut torque application chart included



168-02880

ASCOT NO.	MFG. NO.	DESCRIPTION
168-02880	12880	10-Piece Torque Limiting Socket Set

ASCOT NO.	MFG. NO.	DESCRIPTION
10-PIECE 1/2" DRIVE TORQUE LIMITING SOCKET SET: KIT CONTENTS		
168-21755	121755M	1/2" Drive 17mm - 55 Ft./lbs. Torque Socket - Green
168-21780	121780M	1/2" Drive 17mm - 80 Ft./lbs. Torque Socket - Red
168-21910	121910M	1/2" Drive 19mm (3/4") - 100 Ft./lbs. Torque Socket - Gray
168-21965	121965M	1/2" Drive 19mm (3/4") - 65 Ft./lbs. Torque Socket - Yellow
168-21980	121980M	1/2" Drive 19mm (3/4") - 80 Ft./lbs. Torque Socket - Blue
168-22180	122180M	1/2" Drive 21mm - 80 Ft./lbs. Torque Socket - Light Brown
168-22212	122212M	1/2" Drive 22mm (7/8") - 120 Ft./lbs. Torque Socket - White
168-22214	122214M	1/2" Drive 22mm (7/8") - 140 Ft./lbs. Torque Socket - Turquoise
168-22610	122610	1/2" Drive 13/16" - 100 Ft./lbs. Torque Socket - Brown
168-23014	123014	1/2" Drive 15/16" - 140 Ft./lbs. Torque Socket - Light Green

1/2" DRIVE 22MM TORQUE SOCKETS

- Constructed from heat treated spring steel
- Solid one-piece construction
- Deep well



168-22110

ASCOT NO.	MFG. NO.	DESCRIPTION
168-22110	122110M	1/2" Drive 22mm 110 Ft./Lb. Torque Socket - Copper APPLICATIONS: Buick LaCrosse 2010+, Regal 2011+, Cadillac XTS 2011+, Chevrolet Camaro 2011+, Saab 9-4X 2010+
168-12254	122115M	1/2" Drive 22mm 154 Ft./Lb. Torque Socket - Pink APPLICATIONS: Toyota Land Cruiser 2004-06, 2008+, Tundra

168-12254

WHEEL SERVICE PRODUCTS // WHEEL TORQUE PRODUCTS



Torque Wrenches & Torque Accessories (cont.)

2017 LUG NUT TORQUE APPLICATION CHART

- Wall chart measuring 2' x 3'
- Provides lug nut specifications for cars and light trucks to Model Year 2017
- For use with Original Equipment wheels
- Laminated for durability
- Shipped in a protective mailing tube
- Similar to Tire Guides Lug Nut Torque Chart



POSTER SIZE

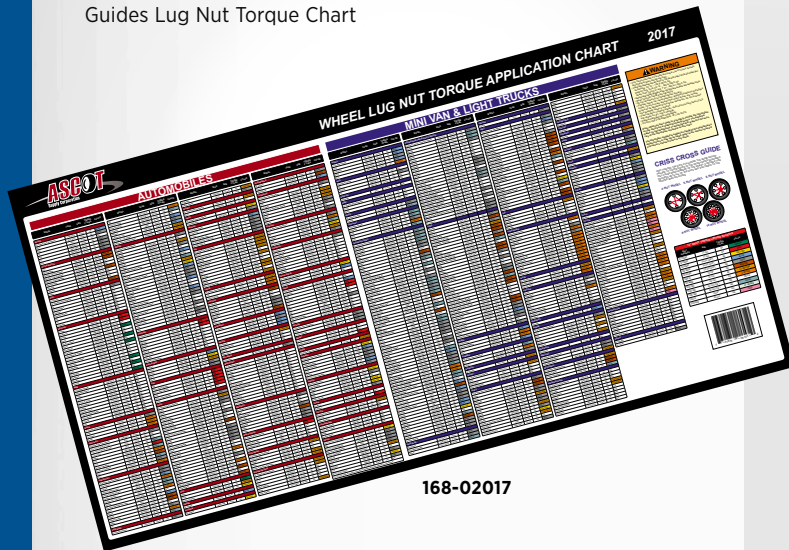

168-02017

ASCOT NO.	MFG. NO.	DESCRIPTION
168-02017	TC2017	2017 Lug Nut Torque Application Chart

1/4" DRIVE TORQUE WRENCH

- Easy-to-read and set for error-free adjustments
- Automatic locking torque adjustment
- Ideal for TPMS applications
- Blow molded case
- RANGE: 10-150 in./lbs.



EASY TO READ



168-00652

ASCOT NO.	MFG. NO.	DESCRIPTION
168-00652	AS-652H	1/4" Drive Torque Wrench

MICRO-ADJUSTABLE TORQUE WRENCH

- Dual scale, calibrated dual direction
- Positive Lock with spring loaded pull down lock ring
- Fast, accurate and easy to set
- Easy-to-read Laser marked scale
- Ergonomic comfort-grip
- Most feature Quick Release buttons which provide good socket retention as well as easy socket removal
- RANGE: 50-250 ft./lbs.
- ACCURACY: ± 4% clockwise ± 6% CCW of indicated value, CW, from 20% to 100% of full scale



DUAL SCALE



168-12250



CALIBRATED DUAL DIRECTION

1/2" DRIVE TORQUE WRENCH

- Dual direction
- Locking collar prevents accidental setting adjustment
- Easy to read laser marked scale
- Blow molded case with calibration certificate
- RANGE: 25-250 ft./lbs.
- OVERALL LENGTH: 25"



EASY TO READ



168-00425

ASCOT NO.	MFG. NO.	DESCRIPTION
168-00425	AS-425	1/2" Drive Torque Wrench

ASCOT NO.	MFG. NO.	DESCRIPTION
168-12250	2503MFRRH	1/2" Drive Micro-Adjustable Torque Wrench



➔ Torque Extensions, Torque Extension Set, Torque Wrench Sets

1" DRIVE TRUCK TORQUE EXTENSIONS

▪ **1" drive square ends** ▪ Once the proper torque is reached the extension will absorb any excess torque

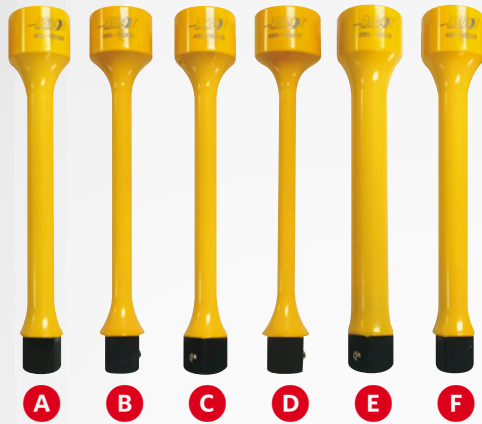

ASCOT NO.	ITEM	MFG. NO.	DESCRIPTION
495-16004	A	1600-P	1" Drive 475 ft./lbs. Torque Limiting Extension
495-16005	B	1600-R	1" Drive 250 ft./lbs. Torque Limiting Extension
495-16006	C	1600-S	1" Drive 350 ft./lbs. Torque Limiting Extension
495-16007	D	1600-T	1" Drive 175 ft./lbs. Torque Limiting Extension
495-16008	E	1600-W	1" Drive 650 ft./lbs. Torque Limiting Extension
495-16009	F	1600-Y	1" Drive 550 ft./lbs. Torque Limiting Extension

1/2" DR 5-PIECE TORQUE EXTENSION SET

▪ **Set includes all 5 extension sockets listed below** ▪ Provides the ability to torque wheel nuts on passenger cars to the correct specification ▪ Set comes in a durable plastic blow molded case ▪ *Individual extensions sold separately*

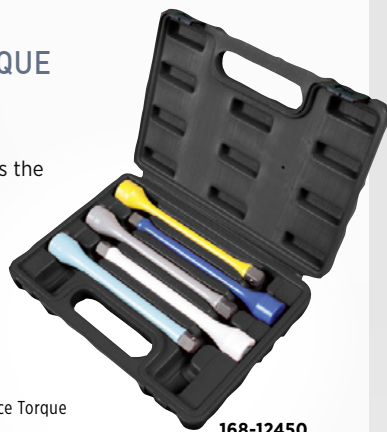

ASCOT NO.	MFG. NO.	DESCRIPTION
168-12450	2450	1/2" DR 5-Piece Torque Extension Set

168-12450

ASCOT NO.	MFG. NO.	DESCRIPTION
1/2" DR 5-PIECE TORQUE EXTENSION SET: KIT CONTENTS		
168-12465	2465	65 Ft./lbs. Extension - Yellow
168-12480	2480	80 Ft./lbs. Extension - Blue
168-12410	24100	100 Ft./lbs. Extension - Gray
168-12412	24120	120 Ft./lbs. Extension - White
168-12414	24140	140 Ft./lbs. Extension - Aqua

ASCOT 6-PIECE WHEEL TORQUE WRENCH SET

▪ **One-way, not bi-directional** ▪ +/- 4% accuracy ▪ Cushioned ratchet head ▪ Color coded presets

ASCOT NO.	MFG. NO.	DESCRIPTION
168-16000	16000	6-Piece Preset/Adjustable (5 Preset - 1 Adjustable) Wheel Torque Wrench Set



168-16000

ASCOT NO.	DESCRIPTION
ASCOT 6-PIECE WHEEL TORQUE WRENCH SET: KIT CONTENTS	
168-12065	65 Ft./lbs. Preset Torque Wrench - Yellow
168-12080	80 Ft./lbs. Preset Torque Wrench - Blue
168-12100	100 Ft./lbs. Preset Torque Wrench - Gray
168-12120	120 Ft./lbs. Preset Torque Wrench - White
168-12140	140 Ft./lbs. Preset Torque Wrench - Aqua
163-91217	1/2" Dr. x 17mm Chrome Socket
163-91219	1/2" Dr. x 19mm Chrome Socket
163-91221	1/2" Dr. x 21mm Chrome Socket
163-91234	1/2" Dr. x 3/4" Chrome Socket
163-91236	1/2" Dr. x 13/16" Chrome Socket
163-91278	1/2" Dr. x 7/8" Chrome Socket
168-12106	1/2" Dr. x 6" Chrome Extension
168-12250	250 Maximum Ft./lbs. Single Direction Micro-Adjustable Torque Wrench
169-12006	Wall Board
168-96509	1/2" Preset Torque Wrench Repair Kit

ASCOT 4-PIECE WHEEL TORQUE WRENCH SET

▪ **One-way, not bi-directional** ▪ +/- 4% accuracy ▪ Cushioned ratchet head ▪ Color coded presets

ASCOT NO.	MFG. NO.	DESCRIPTION
168-13000	13000	4-Piece Preset Wheel Torque Wrench Set



168-13000

ASCOT NO.	DESCRIPTION
ASCOT 4-PIECE WHEEL TORQUE WRENCH SET: KIT CONTENTS	
168-12080	80 Ft./lbs. Preset Torque Wrench - Blue
168-12100	100 Ft./lbs. Preset Torque Wrench - Gray
168-12120	120 Ft./lbs. Preset Torque Wrench - White
168-12140	140 Ft./lbs. Preset Torque Wrench - Aqua
163-91217	1/2" Dr. x 17mm Chrome Socket
163-91219	1/2" Dr. x 19mm Chrome Socket
163-91221	1/2" Dr. x 21mm Chrome Socket
163-91234	1/2" Dr. x 3/4" Chrome Socket
163-91236	1/2" Dr. x 13/16" Chrome Socket
163-91278	1/2" Dr. x 7/8" Chrome Socket
169-12006	Wall Board

Blue Tork, Torque Wrenches

Torque Wrenches & Torque Accessories (cont.)



1" BLUE TORK

▪ **Two pneumatic motor for rundown and final tightening** ▪ Preset and adjustable shut off for torque control ▪ **ERGONOMICS:** Very low noise level, virtually no vibration ▪ **EFFICIENCY:** Precise and accurate tightening, less fatigued operators ▪ **ENVIRONMENT IMPROVEMENTS:** by increasing durability of the tools, we reduce waste ▪ **QUALITY:** Precise, accurate tightening to the manufacturer's recommended torque and angle specifications ▪ **MAXIMUM TORQUE:** 660 ft./lbs.

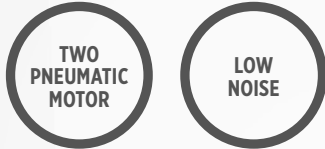

Training required prior to use.

168-07600

ASCOT NO.	MFG. NO.	DESCRIPTION
168-07600	CP-7600xB	Non-Reversible Single Torque Preset
168-07602	CP-7600xB-R	Reversible Single Torque Preset
168-07603	CP-7600xB-R4P	Reversible 4 Torque Preset Selector

FRL UNIT FOR BLUE TORK

▪ **INCLUDES:** Industrial grade filter; Regulator; Single point lubricator; 25' hose with capillary tube; 1 Quart of special tool oil approved for the Blue Tork



117-58625

ASCOT NO.	MFG. NO.	DESCRIPTION
117-58625	586-254-1000	FRL Unit for Blue Tork

PRESET TRUCK CLICKER STYLE TORQUE WRENCH

▪ **Preset at 475 ft./lbs.** ▪ Designed for fleet applications ▪ **Massive 4-1/2' length** for high torque applications ▪ Supplied with handy storage bag for sockets and extensions ▪ Both the wrench and the bag have reflective strips for safe highway night use

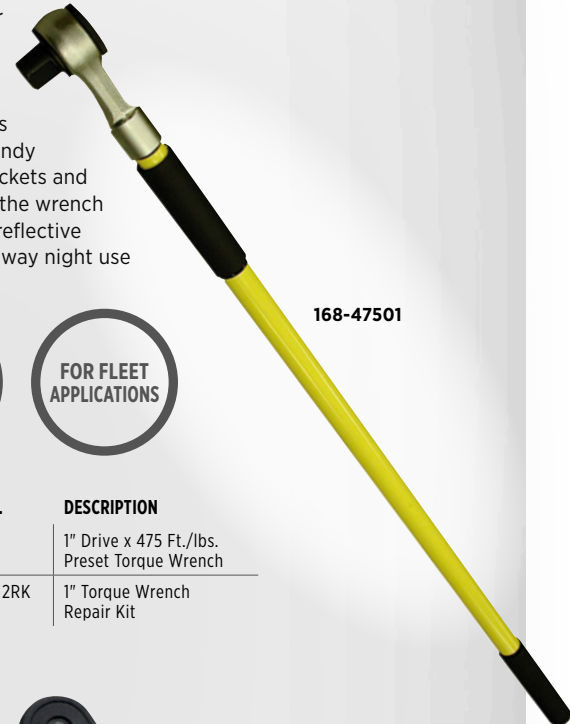

168-47501



ASCOT NO.	MFG. NO.	DESCRIPTION
168-47501	1-475	1" Drive x 475 Ft./lbs. Preset Torque Wrench
168-96112	9610-0112RK	1" Torque Wrench Repair Kit



MICRO-ADJUSTABLE TORQUE WRENCH

▪ **Dual scale, calibrated dual direction** ▪ Positive lock with spring loaded pull down lock ring ▪ Fast, accurate and easy to set ▪ Easy-to-read Laser marked scale ▪ Ergonomic comfort-grip ▪ Most feature Quick Release buttons which provide good socket retention as well as easy socket removal ▪ **RANGE:** 50-250 ft./lbs. ▪ **ACCURACY:** ± 4% clockwise ± 6% CCW of indicated value, CW, from 20% to 100% of full scale



168-12250

ASCOT NO.	MFG. NO.	DESCRIPTION
168-12250	2503MFRRH	1/2" Drive Micro-Adjustable Torque Wrench

WHEEL SERVICE PRODUCTS // WHEEL TORQUE PRODUCTS



➔ Flex Hinge Torque Wrench, Pneumatic Torque Multiplier, Torque Wrench Checker



FLEX HINGE TORQUE WRENCH

- **Robust construction achieves accurate results to +/- 4%** ▪ Flex hinge design provides unmistakable signal
- Flex angle makes it virtually impossible to overtorque
- Torques both right and left-handed threads
- Calibrated and certified to ISO Standards
- Scale reads in ft./lbs. ▪ 3/4" or 1" drive x 13" extension available



6 Oz. Oil Can
ASCOT NO. **329-50515**
MFG. NO. **PLW50-515**



168-12017



168-60020 168-60025



Plastic carrying case included with flex-hinge torque wrenches.

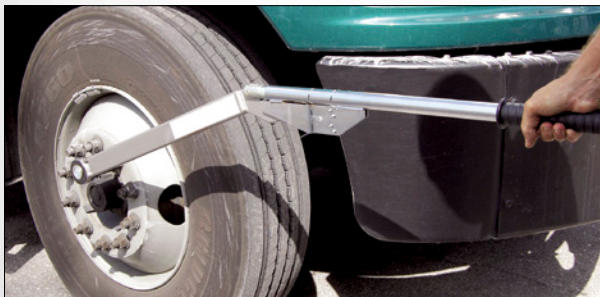

The flex-hinge torque wrench in use.

ASCOT NO.	MFG. NO.	DESCRIPTION
168-12007	12007	3/4" Drive 600 Ft./lbs. Capacity
168-12017	12007.01	1" Drive 600 Ft./lbs. Capacity
168-12009	12009	3/4" Drive 750 Ft./lbs. Capacity
168-12019	12009.01	1" Drive 750 Ft./lbs. Capacity
168-12997	12297	3/4" Drive Block for Flex Hinge Torque Wrench
168-12999	12299	1" Drive Block for Flex Hinge Torque Wrench
168-60020	12299	1" Square Drive for Flex Hinge Torque Wrench
168-60025	12297	3/4" Square Drive for Flex Hinge Torque Wrench
169-02013	2013E	3/4" Drive x 13" Impact Extension
169-03013	3013E	1" Drive x 13" Impact Extension
169-13413	13413E	3/4" Drive x 1" Drive x 13" Impact Extension

PNEUMATIC TORQUE MULTIPLIER

- **OPERATING RANGE:** 147 to 738 ft./lbs. (200 to 1000 Nm)
- 'Soft Start' trigger control aids socket location, and allows gradual and safe reaction location
- Extended reaction is ideal for reaching recessed nuts
- **FAST:** 1000 Nm version has a free speed of 140 rpm for rapid bolt run-down
- For safety, gearbox can rotate independently from the handle so that reaction forces are not transmitted back to the operator
- Light weight for ease of handling
- **NON IMPACTING:** Low vibration levels make these tools comfortable and safe to use
- On Bi-Directional tools, the direction control knob is locked while the tool is running to prevent accidental damage to the gearbox
- **QUIET:** Less than 85 dB(A) when under load
- Square drive is quickly and easily replaceable



168-18141

ASCOT NO.	MFG. NO.	DESCRIPTION
168-18141	PTME-72-2000-B	1" Square Drive Bi-Directional Pneumatic Multiplier

NORBAR 750 FT./LBS. TORQUE WRENCH CHECKER

The 43237 Torque Wrench Checker is an accurate and simple to operate torque wrench checker. There is only one button; used to zero the unit prior to measurement.

- **Accurate and Durable** ▪ Easily portable or can be fixed and mounted
- No special skills required to use
- Can be provided with options
- **APPLICATION:** For use with click or break style, or dial torque wrenches



ASCOT NO.	MFG. NO.	DESCRIPTION	168-43237
168-43237	43237	Norbar 750 lb-ft Torque Wrench Checker	

WHEEL SERVICE PRODUCTS // WHEEL TORQUE PRODUCTS

→ Torque Wrenches

Torque Wrenches & Torque Accessories (cont.)



MICROMETER TORQUE WRENCHES

▪ **EXTREMELY ACCURATE:** Within 3% of reading from 20% of full scale to full scale clockwise and counter-clockwise ▪ **EXCLUSIVE PATENTED CALIBRATION MECHANISM:** This patented mechanism allows for calibration in both the clockwise and counter-clockwise directions, plus with regard to spring rate, without the disassembly of the wrench. This protects against contamination of the working mechanism, and make calibration quick and easy ▪ **EXCLUSIVE PATENTED ROLLER-RELEASE:** This patented feature removes over 95% of the friction inherent in other click wrenches thereby extending life and providing for more reliable operation. ▪ **ALL "M" SERIES MEETS OR EXCEEDS ALL APPLICABLE REQUIREMENTS OF:** ANSI / ASME B107.14M, GGG-W-00686C, BS6073: 1988, ISO6789



168-03252

ASCOT NO.	MFG. NO.	DESCRIPTION
168-01200	M1R200H	1/4" Drive
168-02101	M2R100F	3/8" Drive
168-03252	M3R250F	1/2" Drive



SPLIT-BEAM CLICK TORQUE WRENCHES

▪ **EXTREMELY ACCURATE:** within 4% of reading from 20% of full scale to full scale ▪ Setting torque on adjustable wrenches is fast and easy because there is no spring tension on the adjustment knob ▪ Torque setting locks on adjustable wrenches for repetitive applications ▪ Wrench length designed to provide the leverage required for maximum torque applications. Also provides the needed reach for those hard to get at places



168-03250

ASCOT NO.	MFG. NO.	DESCRIPTION	FT./LBS.
168-02100	C2FR100F	3/8" Drive	100
168-03250	C3FR250F	1/2" Drive	250
168-03251	CP3FR250F	1/2" Preset	250
168-04400	C4D600F	3/4" Drive	600
168-05600	C5D600F	1" Drive	600

CLIKKER TORQUE WRENCH

▪ **Loud click tells you when you've reached the torque setting** ▪ Feature ratchet-style heads, all metal construction, permanently roll-marked scales and soft-grip rubber handles ▪ Molded plastic carrying case



ASCOT NO.	MFG. NO.	DRIVE	LENGTH	TORQUE/RANGE/GRADUATIONS
495-07375	7375	3/8"	15-1/8"	150-750 in.-lbs. /10 in.-lbs.
495-07377	7377	1/2"	17-3/4"	30-150 ft./lbs. /2 ft./lbs.
495-07378	7378	1/2"	19-3/8"	50-250 ft./lbs. /2 ft./lbs.
495-07379	7379	3/4"	42-1/4"	100-600 ft./lbs. /10 ft./lbs.

WHAT IS TORQUE?

Torque is the measurement of twisting force that is applied to a lug nut to create bolt tension.

WHAT IS CLAMPING FORCE?

Clamping force is the result of bolt tension and it is the physical property that holds the wheels on the vehicle.

DOES THE CORRECT TORQUE GUARANTEE THE CORRECT CLAMPING FORCE?

No. Clamping force cannot be measured in the field, so technicians must use the correct torque to approximate the amount of clamping force.

Since there are a number of factors that determine how much clamping force is generated per foot pound of torque, technicians should always **follow the RIST procedure** developed by the Tire Industry Association (TIA).



R

stands for
remove debris from
mating surfaces



I

stands for
inspect all of the
components



S

stands for
snug the lug nuts
in a star pattern

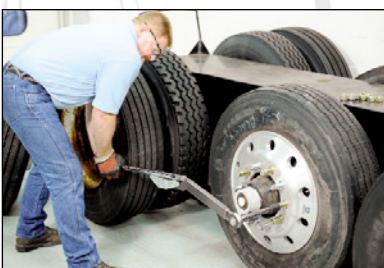
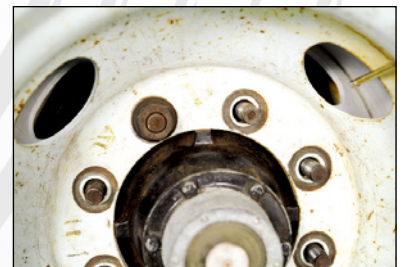

T

stands for
torque the fasteners
to specification



TORQUE SPECIFICATIONS

Hub-Pilot Wheel: 450-500 ft/lbs. oiled | Stud-Pilot Wheel: 450-500 ft/lbs. dry | Demountable Rim: 200-260 ft/lbs. dry

TIA is the industry leader in commercial truck tire and wheel service education. Since Occupational Safety and Health Administration (OSHA) Regulation 29 CFR 1910.177 requires training for all employees that service truck tires, fleets must make sure that every technician who installs, removes or handles truck tires in any way has compliant training. TIA developed the Fleet Tire Service OSHA Compliance Program so the trucking industry could provide in-house technician training that exceeds the minimum requirements established by 29 CFR 1910.177.

For more information on TIA training or the RIST procedure, visit TIA's website: <http://www.tireindustry.org/training.asp> or call 800-876-8376, ext. 106.



Torque Wrenches & Torque Accessories (cont.)

TORQUE MULTIPLIERS

- Increase the range of your torque wrench as much as 14 to one with a Central Torque Multiplier
- Designed with four pinion gears in a compact housing, these multipliers expand your torque wrench range by their stated ratio



495-06380

ASCOT NO.	MFG. NO.	RATE	DRIVE INPUT	DRIVE OUTPUT	MAX. OUTPUT CAP	WEIGHT (LBS.)	BODY LENGTH	TOTAL LENGTH
495-06380	6380	4:1	1/2"	3/4"	1,000 In.-lbs.	7	6.6"	22"
495-06382	6382	4.33:1	1"	1-1/2"	4,000 In.-lbs.	35	9.7"	30"
495-06383	6383	4.6:1	1"	1-1/2"	8,000 In.-lbs.	47	12.1"	32"
495-06384	6384	6:1	1"	2-1/2"	12,000 In.-lbs.	78	11.5"	30"
495-06386	6386	14.3:1	3/4"	1-1/2"	3,000 In.-lbs.	30	9.7"	30"
495-06387	6387	4:1	3/4"	1"	2,000 In.-lbs.	14	6.6"	25"

MICROMETER TORQUE WRENCHES

- Set desired torque on micrometer type scale by rotating hand grip
- Automatically indicates desired torque by feel and sound
- No need to worry about getting a reading
- Wrench torques left or right and resets in seconds
- Accurate throughout entire torque range
- **DUAL SCALE:** English and international Metric
- Chrome finish
- **ACCURACY:** +/-4%CW and +/-6%CCW
- 20% - 80% of capacity
- Metal hand grip is resistant to damage from striking or automotive fluids such as gasoline, oil and kerosene
- **RATCHET HEAD:** The 45-tooth ratchet is designed for speedy torquing and operating in restricted areas

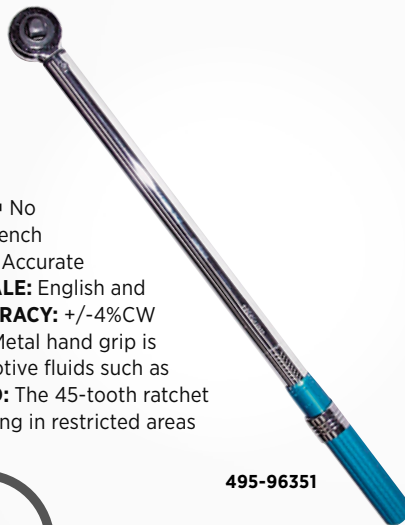

495-96351

ASCOT NO.	MFG. NO.	RANGE (INCREMENT)	DRIVE	LENGTH	WEIGHT (LBS.)
495-96351	96351	25-250 In.-lbs. (1 in.-lbs.)	3/8" Ratchet	12.6 inches	1.4
495-96352	96352	10-100 In.-lbs. (5 In.-lbs.)	3/8" Ratchet	17.3 inches	1.9
495-96353	96353	25-250 In.-lbs. (1 In.-lbs.)	1/2" Ratchet	20.0 inches	2
495-96355	96355	100-600 In.-lbs. (5 In.-lbs.)	3/4" Ratchet	38.5 inches	0.5
495-96361	96361	20-200 In.-lbs. (1 In.-lbs.)	1/4" Ratchet	12.4 inches	1.5
495-96395	96395	10-80 In.-lbs. (In.-lbs.)	3/8" Flexhead	17.6 inches	2.2

MICROMETER TORQUE WRENCH

168-97354

- Range is 25 to 250 ft./lbs.
- **HEAVY DUTY RATCHET:** Fewer and stronger teeth
- **UNIDIRECTIONAL TORQUEING:** Tightens in right hand direction only, does not tighten in left hand direction for improved performance



- **ERGONOMICALLY DESIGNED HANDLE MADE FROM MODIFIED SILICONE:** Tear resistant, oil and solvent resistant
- Protective head cover made from modified silicone
- Comes in plastic storage case
- **MADE IN USA**



ASCOT NO.	MFG. NO.	DESCRIPTION
168-97354	97354	Micrometer Torque Wrench: 25-250 Ft./Lbs.



WHEEL SERVICE PRODUCTS // WHEEL TORQUE PRODUCTS

Loose Nut Prevention



ROLLOCK - LOOSE NUT PREVENTION

▪ **Cost effective way to prevent wheel nuts from loosening** ▪ Galvanized steel product locks wheel nuts in place ▪ **APPLICATION:** ROLLOCK is for use on 19.5 & 22.5 Hub-Piloted Wheels (8 or 10 hole) ▪ **ROLLOCK IS EASY TO REMOVE:** Unscrew the Wheel Nut in normal manner and the ROLLOCK clamp will easily come off



LOCKS
WHEEL NUTS
IN PLACE

COST
EFFECTIVE

The Rollock is a cost effective way to prevent nuts from loosening.

LUG LOCK WHEEL NUT RETAINERS

▪ **Use the resistance between two nuts to minimize their ability to rotate and loosen** ▪ Flexible and easy to install, fits over two adjacent nuts ▪ Field tested at high and low rotation levels ▪ Lab tested in severe vibration conditions ▪ **APPLICATION:** Designed to be used on wheels with 33mm nuts on 3.5" stud centers ▪ Compatible with a complete wheel mounting safety program ▪ *Other sizes and colors available*



402-62600



Other sizes and colors available.

FLEXIBLE
& EASY TO
INSTALL

FIELD
TESTED



The Lug Lock Wheel Nut Retainers in use.

ASCOT NO.	MFG. NO.	DESCRIPTION
402-62000	62000	Rollock, 4-1/8" Spacing, 30-33mm Nut
402-62500	62500	Rollock, 3-1/2" Spacing, 30-33mm Nut

ASCOT NO.	MFG. NO.	DESCRIPTION
402-62600	62600	3 1/2" Spacing, 350 degrees

WHEEL SERVICE PRODUCTS // LOOSE NUT PREVENTION



Loose Nut Prevention (cont.)

CHECKPOINT LOOSE WHEEL NUT INDICATORS*



- A simple and cost effective product that can help guard against a potential catastrophic loss caused by loose lug nuts when used as part of a total torque wheel program
- When fitted on properly torqued wheel nuts and inspected by a driver or technician, the Checkpoints clearly and visually indicate if the wheel nuts have moved
- If the arrows have moved from the point-to-point pattern, this indicates that they have loosened and need attention
- Enhanced fleet safety management
- Facilitates the driver's check for wheel nut movement and his involvement with vehicle safety
- Early warning for mechanic or driver of excessive heat caused by possible brake or bearing problems
- Demonstrate your fleet commitment to vehicle road worthiness and safety
- **QUANTITY:** 100 per bag

SIMPLE & EASY TO USE

COST EFFECTIVE

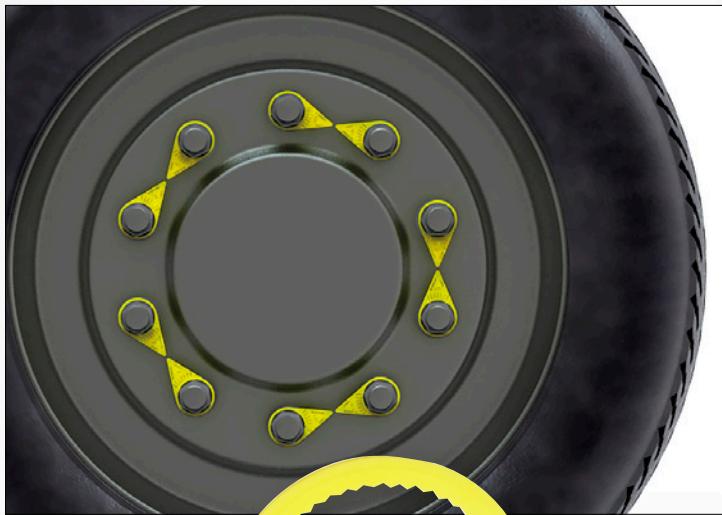

The Checkpoint Loose Wheel Nut Indicators in use.

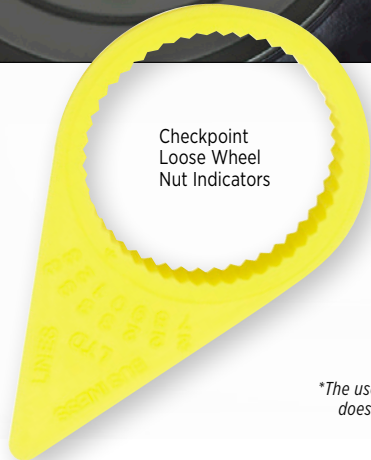

Checkpoint Loose Wheel Nut Indicators

ASCOT NO.	MFG. NO.	DESCRIPTION
CHECKPOINT		
402-20017	CPY17MM	Checkpoint 17MM Fluorescent Yellow Loose Wheel Nut Indicator
402-20018	CPY18MM	Checkpoint 18MM Fluorescent Yellow Loose Wheel Nut Indicator
402-20019	CPY19MM	Checkpoint 19MM Fluorescent Yellow Loose Wheel Nut Indicator
402-20020	CPY20MM	Checkpoint 20MM Fluorescent Yellow Loose Wheel Nut Indicator
402-20021	CPY21MM	Checkpoint 21MM Fluorescent Yellow Loose Wheel Nut Indicator
402-20078	CPY22MM	Checkpoint 22MM (7/8") Fluorescent Yellow Loose Wheel Nut Indicator
402-20023	CPY23MM	Checkpoint 23MM Fluorescent Yellow Loose Wheel Nut Indicator
402-20024	CPY24MM	Checkpoint 24MM Fluorescent Yellow Loose Wheel Nut Indicator
402-20001	CPY25MM	Checkpoint 25MM (1") Fluorescent Yellow Loose Wheel Nut Indicator
402-20026	CPY26MM	Checkpoint 26MM Fluorescent Yellow Loose Wheel Nut Indicator
402-20027	CPY27MM	Checkpoint 27MM Fluorescent Yellow Loose Wheel Nut Indicator
402-20028	CPY28MM	Checkpoint 28MM Fluorescent Yellow Loose Wheel Nut Indicator
402-20029	CPY29MM	Checkpoint 29MM Fluorescent Yellow Loose Wheel Nut Indicator
402-20030	CPY30MM	Checkpoint 30MM Fluorescent Yellow Loose Wheel Nut Indicator
402-20114	CPY31MM	Checkpoint 31MM (1-1/4") Fluorescent Yellow Loose Wheel Nut Indicator
402-20032	CPY32MM	Checkpoint 32MM Fluorescent Yellow Loose Wheel Nut Indicator
402-20033	CPY33MM	Checkpoint 33MM Fluorescent Yellow Loose Wheel Nut Indicator
402-20034	CPY34MM	Checkpoint 34MM Fluorescent Yellow Loose Wheel Nut Indicator
402-20035	CPY35MM	Checkpoint 35MM Fluorescent Yellow Loose Wheel Nut Indicator
402-20036	CPY36MM	Checkpoint 36MM Fluorescent Yellow Loose Wheel Nut Indicator
402-20015	CPY38MM	Checkpoint 38MM (1-1/2") Fluorescent Yellow Loose Wheel Nut Indicator
402-20040	CPY40MM	Checkpoint 40MM Fluorescent Yellow Loose Wheel Nut Indicator
402-20041	CPY41MM	Checkpoint 41MM Fluorescent Yellow Loose Wheel Nut Indicator
402-20044	CPY44MM	Checkpoint 44MM Fluorescent Yellow Loose Wheel Nut Indicator
402-20046	CPY46MM	Checkpoint 46MM Fluorescent Yellow Loose Wheel Nut Indicator

*The use of Checkpoint Loose Wheel Nut Indicators does not guarantee wheel-offs will not occur.



→ Checkpoint Loose Wheel Nut Indicators



ASCOT NO.	MFG. NO.	DESCRIPTION
CHECKPOINT HI-TEMP		
402-21019	CPOHY19MM	Checkpoint 19MM Orange Hi-Temp Loose Wheel Nut Indicator
402-21021	CPOHY21MM	Checkpoint 21MM Orange Hi-Temp Loose Wheel Nut Indicator
402-21022	CPOHY22MM	Checkpoint 22MM Orange Hi-Temp Loose Wheel Nut Indicator
402-21030	CPOHY30MM	Checkpoint 30MM Orange Hi-Temp Loose Wheel Nut Indicator
402-21031	CPOHY31MM	Checkpoint 31MM Orange Hi-Temp Loose Wheel Nut Indicator
402-21032	CPOHY32MM	Checkpoint 32MM Orange Hi-Temp Loose Wheel Nut Indicator
402-21033	CPOHY33MM	Checkpoint 33MM Orange Hi-Temp Loose Wheel Nut Indicator
402-21036	CPOHY36MM	Checkpoint 36MM Orange Hi-Temp Loose Wheel Nut Indicator
402-21038	CPOHY38MM	Checkpoint 38MM Orange Hi-Temp Loose Wheel Nut Indicator
402-21040	CPOHY40MM	Checkpoint 40MM Orange Hi-Temp Loose Wheel Nut Indicator
402-21041	CPOHY41MM	Checkpoint 41MM Orange Hi-Temp Loose Wheel Nut Indicator
402-21044	CPOHY44MM	Checkpoint 44MM Orange Hi-Temp Loose Wheel Nut Indicator
402-21046	CPOHY46MM	Checkpoint 46MM Orange Hi-Temp Loose Wheel Nut Indicator
CHECKTORQUE		
402-22032	CPTR32MM	Checktorque 32MM Red Loose Wheel Nut Indicator
402-22033	CPTR33MM	Checktorque 33MM Red Loose Wheel Nut Indicator
402-22038	CPTR38MM	Checktorque 38MM Red Loose Wheel Nut Indicator
POINT TO POINT		
402-23033	CPTRPP33MM	Checktorque Point to Point 33MM Red Loose Wheel Nut Indicator
402-20133	CPCYPP33MM	Checkpoint Caution Yellow Med. Arrow 33MM Loose Wheel Nut Indicator
402-23133	CPOHTPP33MM	Checkpoint Point to Point 33MM Orange Hi-Temp Wheel Nut Indicator

ASCOT NO.	MFG. NO.	DESCRIPTION
DUSTITE		
402-24027	CPDTY27MM	Dustite Yellow 27MM Loose Wheel Nut Indicator
402-24028	CPDTY28MM	Dustite Yellow 28MM Loose Wheel Nut Indicator
402-24030	CPDTY30MM	Dustite Yellow 30MM Loose Wheel Nut Indicator
402-24032	CPDTY32MM	Dustite Yellow 32MM Loose Wheel Nut Indicator
402-24033	CPDTY33MM	Dustite Yellow 33MM Loose Wheel Nut Indicator
402-24038	CPDTY38MM	Dustite Yellow 38MM Loose Wheel Nut Indicator
402-24133	CPDTSG33MM	Dustite Silver Gray 33MM Loose Wheel Nut Indicator
DUSTITE LONG REACH		
402-25032	CPDTRLR32MM	Dustite Long Reach Yellow 32MM Loose Wheel Nut Indicator
402-25033	CPDTRLR33MM	Dustite Long Reach Yellow 33MM Loose Wheel Nut Indicator
402-25133	CPDTRLRSG33MM	Dustite Long Reach Silver Gray 33MM Loose Wheel Nut Indicator
402-25021	CPDTRLR21MM	Dustite Long Reach Yellow 21MM Loose Wheel Nut Indicator
402-25022	CPDTRLR22MM	Dustite Long Reach Yellow 22MM Loose Wheel Nut Indicator

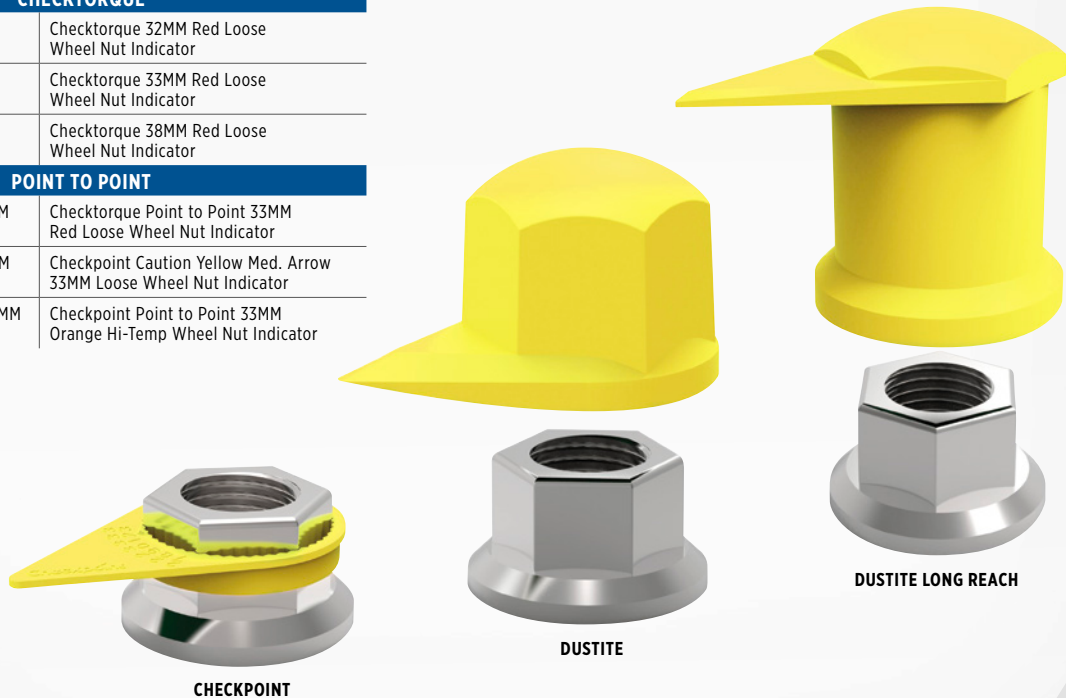

*The use of Checkpoint Loose Wheel Nut Indicators does not guarantee wheel-offs will not occur.

WHEEL SERVICE PRODUCTS // LOOSE NUT PREVENTION



Wheel Centering Products

WHEEL CENTERING PRODUCTS FOR HUB PILOTED WHEELS

- 1 Increases **fuel mileage**
- 2 Increases **tire life**
- 3 Decreases **tire vibration**
- 4 Cuts **rebalancing costs**
- 5 Reduces **"wheel-off" condition**
- 6 Reduces **tire cupping**

Wheel Vibrations? Wheel Hop? Brake Pedal Pulsations? Erratic Tire Wear? Excessive Fuel Consumption?

If you are experiencing these problems, it may be because your wheels aren't centered on the hub. And if your wheels aren't centered, you will continue to experience these problems. With Specialty Products' Wheel Centering Products, you can re-center your wheel, and eliminate all of these problems.

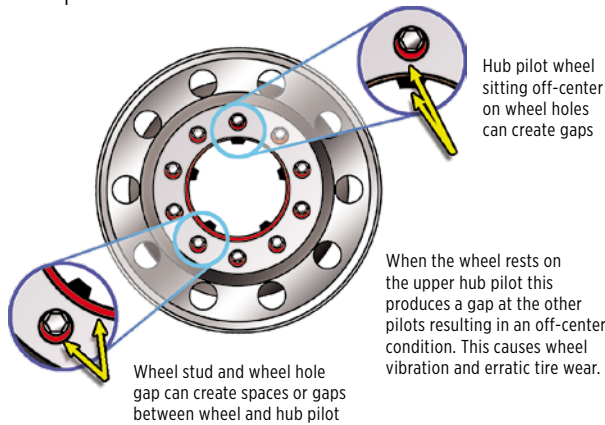

How it works

If your hub piloted wheel is sitting on the hub stud off-center (as shown in the illustration to the left) you need these parts and tools to avoid wheel hop and excess tire wear, and to increase your fuel mileage. The theory behind the hub pilot is it centers the wheel. The fact is gravity causes the weight of the wheel to rest only on the upper pilots creating a gap in the bottom pilots. Even the smallest gap results in an egg shaped motion upon rotation. This uneven motion creates rolling resistance which causes tire vibration, increased fuel consumption and erratic tire wear. The bottom line is, you can't balance an egg.

"EZ ON" WHEEL CENTERING TOOL SET

Simply slide the 3 centering tapered tools over the wheel studs at the 12, 8, and 4 o'clock positions; mount wheel and add lugnuts; remove the tools and replace remaining lugnuts, torquing to manufacturer specifications. The wheel is now completely centered. Problem Solved!



- **Threadless Design** ▪ Saves Installation Time
- Tapered Nose ▪ Eases Wheel Mounting
- Single Set ▪ **APPLICATION:** For Steer, Drive & Trailer Axles

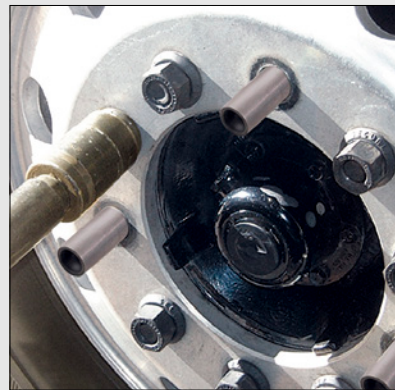

Our new threadless design allows the installer to quickly and easily center the wheels to the hub. And our tapered design makes it easy to mount the wheel over the hub.

ASCOT NO.	MFG. NO.	DESCRIPTION
491-32111	32111	"EZ On" Wheel Centering Tool Set

"EZ ON" WHEEL & BRAKE DRUM CENTERING SLEEVES

▪ **These sets center both steer axle HD wheels and brake drums to minimize wheel vibrations, brake pedal pulsations and wheel hop** ▪ **APPLICATION:** For both Aluminum and Steel steer wheels and a variety of brake drum types



ASCOT NO.	MFG. NO.	DESCRIPTION
491-32120	32120	Aluminum 1.25" hole/.5" depth
491-32121	32121	Aluminium 1.25" hole/.25" to .3125" depth
491-32124	32124	Steel 1.25" hole/.5" depth

➔ Wheel Stud Alignment Tool, Wheel Centering Pin Sets & Sleeves



O-LINE-ER WHEEL STUD ALIGNMENT TOOL

- Makes it easy to line up wheel studs with holes in rim for easy installation
- Decreased installation time
- Increase worker productivity
- Reduce risk of injury from struggling with heavy tires and rims



491-00101

ASCOT NO.	MFG. NO.	DESCRIPTION
491-00101	GTO-01TB	O-Line-Er Wheel Stud Alignment Tool

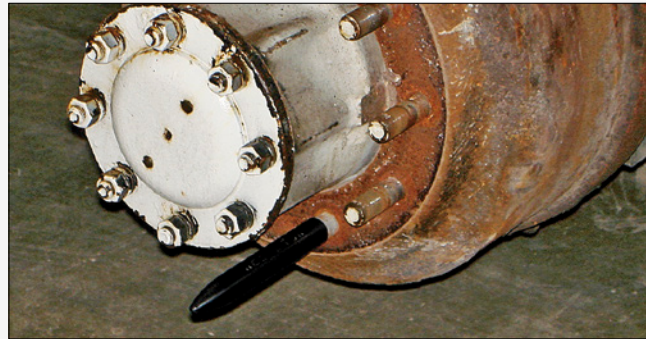

The O-Line-Er Wheel Stud Alignment Tool makes it easy to line up wheel studs with holes in rim for easy installation.

“SOLUTION A” WHEEL CENTERING PIN SETS

- Reusable Shop Tool
- Hardened Steel
- Threaded Inside for Easy Removal
- Sold in sets of 3 with storage case

ASCOT NO.	MFG. NO.	DESCRIPTION
491-02666	A-2666	Steer & Drive axles, 5-1/2" length, Steel & Aluminum wheels, will center 1" brake drums
491-01573	A-1573	Steer & Drive axles and some trailers, 4" length, Steel & Aluminum Wheels
491-01339	A-1339	Steer axles, 3" length, Steel & Aluminum wheels



491-02666

491-01573

491-01339

“SOLUTION B” INTERNAL CENTERING SLEEVES

- Threaded Inside for best positioning and retention
- Stays on wheels
- Zinc plated to resist corrosion
- Sold in sets of 6 per axle



ASCOT NO.	MFG. NO.	DESCRIPTION	GUNITE #	WEBB #	ARVIN MERITOR #
491-01504	B-1504-GA	1.25" diameter hole, 1/4"-5/16" hole depth	3573X	3710X	61528B
			2596X	3721AX	65548B
			2597X	3726X	65554B
			3598X	3758X	65710B
			3686X	3774X	
			3687X	3800X	

ASCOT NO.	MFG. NO.	DESCRIPTION	CONMET #
491-01825	B-1825-CON-A	1.34-1.37" diameter hole, 1/2" hole depth	10009920

ASCOT NO.	MFG. NO.	DESCRIPTION	CONMET #		
491-01860	B-1860-CON-A	1.27" diameter hole, 1/2" depth	107164	107862	10005331
			107193	107453	10001783
			10757	10001781	10005332

ASCOT NO.	MFG. NO.	DESCRIPTION	GUNITE #	MOTOR WHEEL CENTRIFUSE #	ARVIN MERITOR #
491-01594	B-1594-CA	1.25" diameter hole, 1/4"-5/16" hole depth	9001X	90089B	53-123512-002
			9000X	89870B	53-123542-002
			9035X	90174BK	53-123627-002
				91265B	
				90600B	
				90137B	



WHEEL SERVICE PRODUCTS // WHEEL CENTERING PRODUCTS

➔ Nut Buddy Lug Nut Remover, Twist Socket Lug Nut Removal Kits

Lug Nut Removal Products



NUT BUDDY LUG NUT REMOVER

- Loosens the most stubborn wheel nuts
- APPLICATION:** Use on commercial or agricultural wheels
- GEAR RATIO:** 58:1
- RATED OUTPUT TORQUE:** 2950 ft/lbs.
- TWO SOCKETS INCLUDED:** 1-1/2" (38mm) and 1-5/16" (33mm)



404-67300

ASCOT NO.	MFG. NO.	DESCRIPTION
404-67300	67300	Nut Buddy Lug Nut Remover

3-PIECE TWIST SOCKET LUG NUT REMOVAL SYSTEM

- Removal of damaged 3/4" and 19mm, 13/16" and 21mm lug nuts
- Two dual-sided twist sockets have a fluted design which gives the sockets a tight grip to remove the most difficult locking and damaged lug nuts from the socket
- Works with 1/2" impact gun or breaker bar for service calls**
- Includes an extractor punch



492-04300



492-04200

ASCOT NO.	MFG. NO.	DESCRIPTION
492-04300	4300	3-Piece Twist Socket Lug Nut Removal System
492-04200	4200	Dual Sided Twist Socket Lug Nut Remover

5-PIECE LOCKING LUG NUT TWIST SOCKET REMOVAL KIT

- METRIC 2-PC. HUB CENTERING NUT:** 33mm hex x 1.5mm thread
- Designed to eliminate imbalance in truck wheels
- Stamped 450-500 ft./lbs.
- Elongated neck for centering the wheel to the hub
- Assembled in USA
- Packaged 75 per master carton



492-04240

ASCOT NO.	MFG. NO.	DESCRIPTION
492-04240	LT-4240	5-Piece Locking Lug Nut Twist Socket Removal Kit

TWIST SOCKET REMOVAL KIT

- This kit easily removes damaged nuts, studs, pipe nipples and bolts
- Comes mounted on a 1/2" rail, individually packaged



492-04400

ASCOT NO.	MFG. NO.	DESCRIPTION
492-04400	LT4400	1/2" Drive 6-Piece Twist Socket Removal Kit

5-PIECE DEEP TWIST SOCKET SET

- Twist sockets are specifically designed to easily remove damaged, rounded or corroded nuts, wheel lugs, bolts, pipes, pipe nipples or studs**
- Simply place the socket so it barely catches the head of the fastener and turn with an air ratchet, hand ratchet, or breaker bar
- The unique spiral fluting bites onto the damaged fastener and won't let go
- APPLICATION:** Designed for general automotive applications
- INCLUDES THE FOLLOWING SOCKETS:** 19mm-3/4", 13/16", 7/8", 15/16", 1"



492-30116

ASCOT NO.	MFG. NO.	DESCRIPTION
492-30116	30116	5-Piece Deep Twist Socket Set

WHEEL SERVICE PRODUCTS // LUG NUT REMOVAL PRODUCTS

➔ Sav-A-Stud Rethreaders, Locking Lug Key Set



**SAV-A-STUD
RETHREADER**

- Damaged studs can be renewed in minutes without removing the caliper rotor or stud
- **APPLICATION:** For disc brake, four wheel drive and front wheel drive vehicles



493-30100

ASCOT NO.	MFG. NO.	DESCRIPTION
493-30100	30100	Passenger Car/ Light Truck Save-A-Stud Rethreader Kit
493-30200	31200	Heavy Duty Truck Save-A-Stud Rethreader

**TRUCK SAV-A-STUD
RETHREADER**

- Repairs wheel studs, spindles and standard threaded studs



493-30125

ASCOT NO.	MFG. NO.	DESCRIPTION
493-30125	31250	3/4"-14 Left Hand, 3/4"-14 Right Hand, 22mm x 1.5mm
493-31270	31270	3/4"-14 Left Hand, 3/4"-14 Right Hand, 22mm x 1.5mm, 1-1/8" Left Hand - 1-1/8" Right Hand



**16-PIECE LOCKING
LUG KEY SET**

- Heat treated chrome vanadium steel construction
- Easily removes locking lug nuts
- Thin wall sockets prevent damage to wheels
- Extra long lug keys keep your wrench away from the wheel preventing nicks and scratches
- Double hex head design fits most lug wrenches
- Packed in blow molded case with color sleeve



HEAVY DUTY

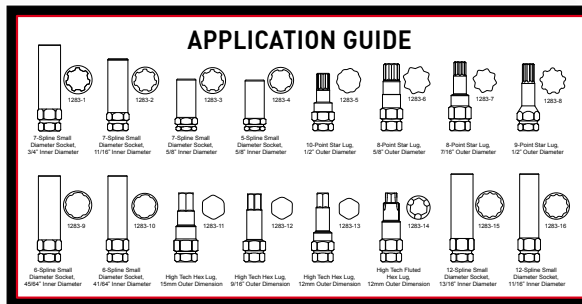

402-01283

KIT CONTENTS

HEX: 11mm, 12mm, 14mm, 15mm, 16mm, 17mm, 18mm, 19mm, 20mm

SOCKETS INCLUDED: (2) 5/8", 41/64", 45/64", (2) 15/32", 19/32", (2) 11/16", 3/4", 7/16", 5/8", (2) 1/2", 13/16", 9/16"

ASCOT NO.	MFG. NO.	DESCRIPTION
402-01283	CHT1283	16-Piece Locking Lug Key Set
402-28301	1283-1	7-Spline Small Diameter Lug Nut Socket - 3/4" Inner Diameter
402-28302	1283-2	7-Spline Small Diameter Lug Nut Socket - 11/16" Inner Diameter
402-28303	1283-3	7-Spline Small Diameter Lug Nut Socket - 5/8" Inner Diameter
402-28304	1283-4	5-Spline Small Diameter Lug Nut Socket - 5/8" Inner Diameter
402-28305	1283-5	10-Point Star Lug Nut Key - 1/2" Tip Outer Diameter
402-28306	1283-6	8-Point Star Lug Nut Key - 5/8" Tip Outer Diameter
402-28307	1283-7	8-Point Star Lug Nut Key - 7/16" Tip Outer Diameter
402-28308	1283-8	8-Point Star Lug Nut Key - 1/2" Tip Outer Diameter
402-28309	1283-9	6-Spline Small Diameter Lug Nut Socket - 45/64" Inner Diameter
402-28310	1283-10	6-Spline Small Diameter Lug Nut Socket - 41/64" Inner Diameter
402-28311	1283-11	High Tech Hex Lug Nut Key - 15mm Hex Size
402-28312	1283-12	High Tech Hex Lug Nut Key - 9/16" Hex Size
402-28313	1283-13	High Tech Hex Lug Nut Key - 12mm Hex Size
402-28314	1283-14	High Tech Fluted Hex Lug Nut Key - 12mm Hex Size
402-28315	1283-15	12-Spline Small Diameter Lug Nut Socket - 13/16" Inner Diameter
402-28316	1283-16	12-Spline Small Diameter Lug Nut Socket - 11/16" Inner Diameter

WHEEL SERVICE PRODUCTS // LUG NUT REMOVAL PRODUCTS

➔ Lug Nut Remover Sets, Wheel Lock Removal Kits

Lug Nut Removal Products (cont.)



4-PIECE LUG NUT REMOVER IMPACT SOCKET SET

▪ **APPLICATION:** Use for removing wheel locks or damaged lug nuts ▪ Patented, internal tapered reverse threads lock onto damaged nut and easily pulls off using impact wrench ▪ Convenient compact storage case ▪ **INCLUDES THE FOLLOWING 1/2" DRIVE SIZES:** 3/4", 13/16", 1", 1-1/8" ▪ **MADE IN USA**



492-30254

ASCOT NO.	MFG. NO.	DESCRIPTION
492-30254	30254	4-Piece Lug Nut Remover Impact Socket Set

4-PIECE HEAVY DUTY WHEEL STUD REMOVER SET

▪ **APPLICATION:** Removes damaged wheel studs and inner Budd nuts ▪ Patented, internal tapered reverse threads lock onto damaged stud or nut and easily pulls off using impact wrench ▪ Wheel Stud Removers are 3/4" hex drive ▪ Budd Nut Removers are 1-1/8" hex drive ▪ Convenient compact storage case, 6.5" x 4.5" x 2.75"; 3.5 lbs ▪ **SET INCLUDES THE FOLLOWING SIZES:** 5/8", 3/4", 1-1/8" Budd wheel inner nut left hand thread, 1-1/8" Budd wheel inner nut right hand thread ▪ **MADE IN USA**



492-30649

ASCOT NO.	MFG. NO.	DESCRIPTION
492-30649	30649	4-Piece Heavy Duty Wheel Stud Remover Set

1/2" DRIVE 13-PIECE WHEEL LOCK REMOVAL KIT

▪ **APPLICATION:** For Ford, Chrysler & GM Vehicles as well as standard and oversized OEM and aftermarket wheel locks for other domestic and imported cars and light trucks



401-02841

KIT CONTENTS	
Ford, Chrysler & Large GM Lock Remover	Oversized McGuard Wheel Lock Adapter
GM Spline Hublock Adapter	Punch
Standard GM Hubcap Locks	Late Model Chrysler Lock Adapter
Stripped 18mm/GM Wheel Cover Adapter	1/2" Dr. 18mm Nut/Corvette GM Lock Remover
Corvette-GM N & F Body Adapter	3/4", 19mm, OS Wheel Lock Remover
Standard Ford & GM/ Large Wheel Adapter	7/8" OS Wheel Lock Remover
	1/2" x 3" Impact Extension

ASCOT NO.	MFG. NO.	DESCRIPTION
401-02841	12840-13	1/2" Drive 13-Piece Wheel Lock Removal Kit

Please contact us for more information regarding **Lug Nut Removal Products**



WHEEL SERVICE PRODUCTS // LUG NUT REMOVAL PRODUCTS



➔ Wheel Lock Removal Kit, Lug Nut Removers

1/2" DRIVE 9-PIECE WHEEL LOCK REMOVAL KIT

▪ **APPLICATION:** For Ford, Chrysler & GM Vehicles as well as standard and oversized OEM and aftermarket wheel locks for other domestic and imported cars and light trucks



401-02840

ASCOT NO.	MFG. NO.	DESCRIPTION
KIT CONTENTS		
401-02840	2840	9-Piece Wheel Lock Remover Kit
401-28401	28401	Individual Wheel Lock Remover for Ford and Chrysler Hubcap Locks
401-28402	28402	Individual Wheel Lock Remover for Ford Wheel Locks and 18mm GM Lug Nuts
401-28403	28403	Individual Wheel Lock Remover for Corvette, GM, N & F Body Wheel Locks
401-28404	28404	Individual Wheel Lock Remover for Oversize McGard Wheel Locks
401-28405	28405	Individual Wheel Lock Remover for McGard Wheel Locks & GM Hubcap Locks
401-28406	28406	Individual Wheel Lock Remover Extractor Punch
401-28407	28407	Individual Wheel Lock Remover for Chrysler Hubcap Locks
401-28408	28408	Individual Wheel Lock Remover for GM Hubcap Locks
401-28409	28409	Individual Wheel Lock Remover for GM Spline Hubcap Locks

ASCOT NO.	MFG. NO.	DESCRIPTION
401-02840	2840	Deluxe Hubcap Wheel Lock Removal System

CHROME LUG NUT COVER REMOVER

ASCOT NO.	MFG. NO.	DESCRIPTION
402-30606	30606	Chrome Lug Nut Cover Remover



402-30606

COMMERCIAL TRUCK CHROME LUG NUT PULLER

▪ **Thick carbon steel material provides strength for heavy duty applications**
 ▪ Round shape handle provides comfort and ease of operation
 ▪ Suitable for all heavy duty truck lug nut applications
 ▪ Two hole design can be switched to expand range and size of application
 ▪ Coated jaws protect painted, aluminum or chrome plated lug nuts from damage



402-03116

ASCOT NO.	MFG. NO.	DESCRIPTION
402-03116	202603-HD	Commercial Truck Chrome Lug Nut Puller

HEAVY DUTY PROFESSIONAL CHROME NUT PULLER

▪ **Coated to prevent scratching or damage to chrome, coated or painted lug covers**
 ▪ Cushioned grip to prevent slippage ▪ **NO ADJUSTMENT REQUIRED:** Fits all 33mm & 1 1/2" covers ▪ *Similar to Ken Tool 30606*



402-03016

ASCOT NO.	MFG. NO.	DESCRIPTION
402-03016	202603	Heavy Duty Professional Chrome Nut Puller with Cushion Handle

WHEEL SERVICE PRODUCTS // LUG NUT REMOVAL PRODUCTS



→ Hub Centric Nut

Wheel Attaching Hardware

HUB CENTRIC NUT

By filling the void between the stud hole, "clocking" is eliminated, and problems caused by clocking, such as wheel offs and wheel hub vibrations, are eliminated.

- **Hub Centric Nut fills void standard flange nuts don't**
- **Stops rim from shifting** forwards or backwards
- **Eliminates "clocking"** caused by standard wheel nuts not filling wheel hole completely
- Metric 2-piece hub centering nut
- **Elongated neck** for centering the wheel to the hub
- **Certified American Steel**
- **Each part tested** for thread, fit and finish
- **QUANTITY:** 50 per box

ASCOT NO.	MFG. NO.	DESCRIPTION
491-00133	X10-PN22B	33mm Hex X 1.5mm Thread

SIDE VIEW



TOP VIEW



491-00133
Hub Centric Nut



Oil Nut



Oil Stud

WHEEL ASSEMBLY WITH STANDARD NUT

Void (Highlighted in Green) between stud and hole

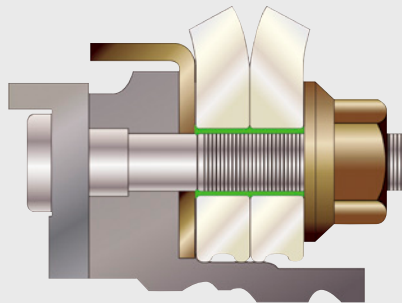

WHEEL ASSEMBLY WITH HUB CENTRIC NUT

Hub Centric Nut fills void between stud and hole

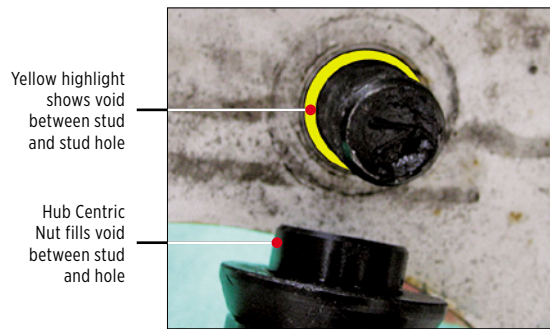
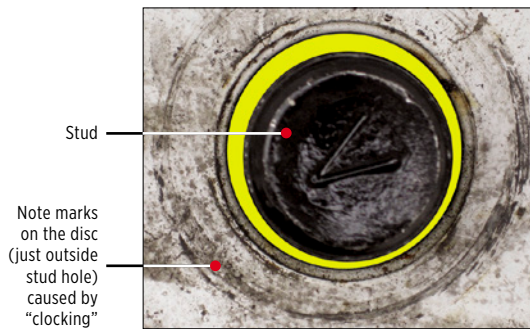
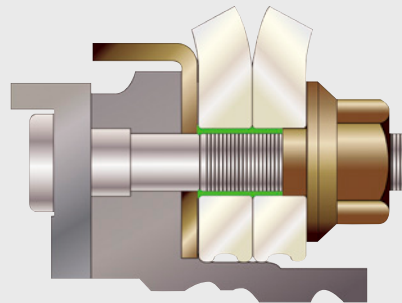

This nut had been torqued to specifications and retorqued per factory settings.

→ Skirt Nuts, Grade 8 Disc Wheel Hardware Cap Nuts



33MM SKIRT NUT

- **Original Skirt Nut**
- Replaces standard M22 flange nuts on 11.25" hub-piloted wheels
- Partially penetrates the stud hole and prevents clocking and vibration
- **QUANTITY:** 100 per case



491-01133

ASCOT NO.	MFG. NO.	DESCRIPTION
491-01133	SN-M22	33mm Skirt Nut

SKIRT NUT

- Stops wheel/hub vibrations and many tire wearing problems
- Stops wheel movement (clocking) on the face of the hub
- Eliminates wasted fuel caused by rolling resistance or "drag"
- Meets and exceeds standards of SAE J1965 for torque tension
- **Replaces all style M22 flange nuts on hub-piloted wheel**
- Hex: 33mm
- Special graphite coating prevents nut from rusting onto the hub
- Fills in the gap between the stud and the bolt 3/16" (5mm)
- **25 per box**



491-02906



491-02919



491-02928



491-02939

Extended threading allowing Skirt Nut to go down into Hub-Piloted Disc Wheel an extra 3/16" (5mm) into stud hole

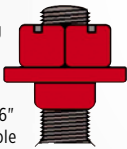

ASCOT NO.	MFG. NO.	DESCRIPTION
491-02906	GL-2906	6mm Designed for Steel - Steers
491-02919	GL-2919	19mm Designed for Aluminum - Steers, Steel/Steel Drives, Steel Outer/Alum. Inner - Drives
491-02928	GL-2928	28mm Designed for HD Aluminum, Super Single - Wide Base, Alum. Outer/Steel Inner - Drives
491-02939	GL-2939	39mm Designed for Dual Aluminum - Drive Axle

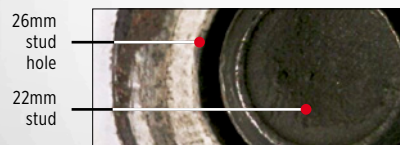

There is a fairly large tolerance between the diameter of each stud hole and the diameter of the stud itself.

GRADE 8 DISC WHEEL HARDWARE-INNER CAP NUTS

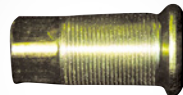

491-01001



491-01003



491-01011

ASCOT NO. FOR SIRCO	SIRCO NO.	ASCOT NO. FOR GLP	GLP NO.	SIMILAR TO:			
491-00708	708AR	491-01001 (RH)	GL-1001	Budd 10708	Euclid 7895R	Leland W-11	Steel/Steel
491-00709	709AL	491-01002 (LH)	GL-1002	Budd 10709	Euclid 7895L	Leland W-12	Steel/Steel
491-00896	896R	491-01003 (RH)	GL-1003	Budd 35336	Euclid 7896R	Leland W-620	Steel/Alum
491-01896	896L	491-01004 (LH)	GL-1004	Budd 35337	Euclid 7896L	Leland W-621	Steel/Alum
491-00897	897R	491-01005 (RH)	GL-1005	Budd 22621	Euclid 7897R	Leland W-616	Steel/Alum
491-01897	897L	491-01006 (LH)	GL-1006	Budd 22622	Euclid 7897L	Leland W-617	Steel/Alum
491-00978	988R	491-01011 (RH)	GL-1011	Alcoa 5988R	Euclid 5988R	Leland W-486	Alum/Alum
491-01978	988L	491-01012 (LH)	GL-1012	Alcoa 5988L	Euclid 5988L	Leland W-487	Alum/Alum
METRIC							
491-00306	306R	491-01009 (RH)	GL-1009	Hino 900423101	Isuzu 1-42335005 - Zinc		
491-01306	306L	491-01010 (LH)	GL-1010	Hino 900424101	Isuzu 1-42336005 - Zinc		

GRADE 8 DISC WHEEL HARDWARE-OUTER CAP NUTS



491-02001



491-02203



ASCOT NO. FOR SIRCO	SIRCO NO.	ASCOT NO. FOR GLP	GLP NO.	SIMILAR TO:			
491-00891	891AR	491-02001 (RH)	GL-2001	Budd 37891	Euclid 5997R	Leland W-13	
491-00892	892AL	491-02002 (LH)	GL-2002	Budd 37892	Euclid 5997L	Leland W-14	
491-00888	888R	491-02101 (RH)	GL-2101	Budd 37888	Euclid 5652R	Leland W-15	
491-00889	889L	491-02102 (LH)	GL-2102	Budd 37889	Euclid 5652L	Leland W-16	
491-00995	995R	491-02103 (RH)	GL-2103	Alcoa 5995R	Euclid 5995R	Leland W-506	
491-01995	995L	491-02104 (LH)	GL-2104	Alcoa 5995L	Euclid 5995L	Leland W-507	
N/A	891BR	491-01891	GL-2004	THRU HARDNESS - GMC-3988631			
N/A	892BL	491-02892	GL-2003				
N/A	N/A	491-02203	GL-2203	Budd 95188	Euclid 9022R	Dodge 3637719	
N/A	N/A	491-02204	GL-2204	Budd 95189	Euclid 9022L	Dodge 3637720	
N/A	N/A	491-02202	GL-2202	Budd 81269	Euclid 5734	GMC 3771410	
N/A	N/A	491-02303	GL-2303	Alca 389928	Ford E4tZ-1012A	N/A	
METRIC							
491-00304	304R	491-02009	GL-2009	Hino 900421112	Isuzu 1-42333023	Leland W-722/3	
491-01304	304L	491-02010	GL-2010	Hino 900422104	Isuzu 1-42334023	Euclid 10254R/L	
491-00033	333B	491-02301	GL-2301	Budd 106333	Euclid 6000A	Leland W-498	
491-00881	881M	491-02302	GL-2302	MW 88881	Euclid 5991	Leland W-492	

WHEEL SERVICE PRODUCTS // WHEEL ATTACHING HARDWARE

➔ Mud Flap Bolt Kit, Spoke Wheel Hardware, Oil Seal Hubs & Gaskets, Cone Wheel Nuts, Brake Drum Mounting Hardware

Wheel Attaching Hardware (cont.)

MUD FLAP BOLT KIT

▪ All the hardware needed to attach mud flaps to trucks or trailers ▪ **INCLUDES:** (4) 3/8"-16 x 1-1/4" bolts, (4) 3/8" Nuts, (8) 3/8" flat washers & (4) 3/8" lock washers

ASCOT NO.	MFG. NO.	DESCRIPTION
491-00038	MFBK	Mud Flap Bolt Kit



491-00038

SPOKE WHEEL HARDWARE



491-03005



491-03002

ASCOT NO. FOR SIRCO	SIRCO NO.	ASCOT NO. FOR GLP	GLP NO.	THREAD	SIMILAR TO:		
RIM CLAMP NUTS							
491-00149	149	491-03004	GL-3004	5/8-11	Dayton 5149	Euclid 4962	Leland W-7
491-00716	716	491-03005	GL-3005	3/4-10	Dayton 5716	Euclid 4963	Leland W-8
RIM STUDS (GRADE 8)							
491-00654	654	491-03001	GL-3001	5/8-11x2-3/4	Dayton 6654	Euclid 4958	Leland W-5
N/A	N/A	491-03002	GL-3002	3/4-10x3	Dayton 5715	Euclid 4956-A	Leland W-6

LOCKING BACK NUTS



491-06023

ASCOT NO.	GLP NO.	SIZE	SIMILAR TO:	
491-06023	GL-6023	5/8"-18	MW 85643	—
491-02431	GL-2431	7/8"-14	Budd 41073-8	Euclid 1835
491-02445	GL-2445	1"-14	Budd 44672-9	Euclid 1828

OIL SEAL HUBCAPS AND GASKETS

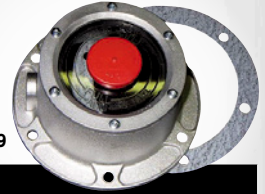

491-04009

ASCOT NO.	MFG. NO.	DESCRIPTION
491-04009	GL-4009	Standard 6-Hole Hubcap
491-04012	GL-4012	6-Hole Gasket for Above
491-04013	GL-4013	Universal Gasket - 5 or 6 Hole
491-04020	GL-4020	Replaceable Window Kit
491-04021	GL-4021	Rubber Plug for Bolt-On Cap
491-09013	GL-4913	Fruehauf/Propar Cap
491-09014	GL-4974	O-Ring for Screw-On Cap
491-09015	GL-4975	Rubber Plug for Screw-On Cap

CONE WHEEL NUTS



491-00014

ASCOT NO.	MFG. NO.	SIZE	DESCRIPTION
491-00014	GL-0014	7/16"-20 (3/4" Hex, 9/16" High)	G.M.
491-00016	GL-0016	1/2"-20 (13/16" Hex, 5/8" High)	Ford
491-00027	GL-0027	1/2"-20 (3/4" Hex, 9/16" High)	Chrysler
491-00062	GL-0062	12mm-1.5 (19mm Hex, 14mm High)	G.M.
491-00066	GL-0066	12mm-1.5 (21mm Hex, 16mm High)	Toyota
491-00065	GL-0065	12mm-1.25 (21mm Hex, 16mm High)	Nissan
491-00064	GL-0064	12mm-1.25 (19mm Hex, 16mm High)	Nissan
491-00052	GL-0052	9/16"-18 (7/8" Hex, 3/4" High)	G.M.
491-00055	GL-0055	R.H. 5/8"-18 (1" Hex, 21/32" High)	Budd 67147
491-00056	GL-0056	L.H. 5/8"-18 (1" Hex, 21/32" High)	Budd 67147

BRAKE DRUM MOUNTING HARDWARE



491-06014

ASCOT NO.	MFG. NO.	SIZE	DESCRIPTION
491-06012	GL-6012	5/8-18 x 2"	5/8" Brake Bolt/Washer/Assembly
491-06014	GL-6014	3/4-16 x 2"	3/4" Brake Bolt/Washer/Assembly
491-06020	GL-6020	5/8-18 x 2"	Brake Bolt Only
491-06021	GL-6021	3/4-16 x 2"	Brake Bolt Only
491-06025	GL-6025	5/8"	Flat Washer
491-06026	GL-6026	3/4"	Flat Washer
491-06023	GL-6023	5/8"-18"	Lock Nut Only
491-06024	GL-6024	3/4"-16"	Lock Nut Only

➔ Rim Clamps, Wheel Guard, Wheel Shield, Wheel Protectors, Installation Tool

RIM CLAMPS



491-03097



491-03113

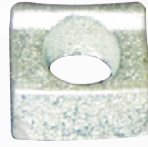

491-06115

ASCOT NO. FOR SIRCO	SIRCO NO.	ASCOT NO. FOR GLP	GLP NO.	A DIM.	B. DIM.	C. DIM.	SIMILAR TO:		
491-00399	399	491-03083	GL-3083	N/A	N/A	N/A	Dayton 8399	Euclid 5927	Leland W-124
491-00729	729	491-03087	GL-3087	N/A	N/A	N/A	Dayton 09-729514	Euclid 5838	Leland W-407
491-00123	123	491-03096	GL-3096	1-1/8"	2-7/8"	2-11/32", 3/4" Stud	Dayton 6123	Euclid 5571A	Leland W-3
491-00235	235	491-03097	GL-3097	1-3/4"	2-7/8"	2-11/32", 3/4" Stud	Dayton 6235	Euclid 5572A	Leland W-4
491-00993	993	491-03098	GL-3098	1-1/2"	2-7/8"	2-11/32", 3/4" Stud	Dayton 6993	Euclid 5040A	Leland w-120
N/A	N/A	491-03099	GL-3099	2-1/8"	2-7/8"	2-11/32", 3/4" Stud	Dayton 705317	Euclid 5786	Leland W-403
N/A	N/A	491-03101	GL-3101	1-7/8"	2-7/8"	2-11/32", 3/4" Stud	Dayton 851817	Webb 16124	Leland W-404
N/A	N/A	491-03103	GL-3103	1-1/4"	2-7/8"	2-11/32", 3/4" Stud	Dayton 8708	Euclid 5784	Leland W-405

ASCOT NO. FOR SIRCO	SIRCO NO.	ASCOT NO. FOR GLP	GLP NO.	SIMILAR TO:		
491-00257	257	491-03113	GL-3113	Mack 15QJ-17P1	Euclid 5828	Leland W-450
491-00238	238	491-03271	GL-3271	Mack 15QJ-223BP8	Euclid 5781	Leland W-448
491-00233	233	491-03279	GL-3279	Mack 15QJ-223BP3	Euclid 5821	Leland W-467
N/A	N/A	491-06115	GL-6115	Kelsey 79954	N/A	N/A

STANDARD WHEEL RIM GUARD

▪ **APPLICATION:** Protects aluminum, chrome and painted truck rims/wheels during stud and nut removal
 ▪ Inexpensive ▪ Tough polymer design

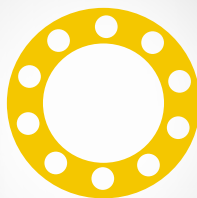

402-50301

ASCOT NO.	MFG. NO.	DESCRIPTION
402-50301	53010	Standard Wheel Rim Guard



The standard wheel rim guard in use.

ALUMINUM WHEEL SHIELD

▪ **APPLICATION:** Covers entire wheel while changing tires ▪ Protects aluminum wheel surface from ground ▪ Torque sequence imprint



402-50200

ASCOT NO.	MFG. NO.	DESCRIPTION
402-50200	52000	Aluminum Wheel Shield



The aluminum wheel shield in use.



INSTALLATION TOOL FOR ALCOA HUB COVER SYSTEMS

▪ **APPLICATION:** For use with Alcoa 076185, 077185, 076188 & 077188 Hub Systems



491-00600

ASCOT NO.	MFG. NO.	DESCRIPTION
491-00600	600	Installation Tool for Alcoa Hub Cover Systems



DISCMATE WHEEL PROTECTORS

▪ **Used to protect the wheel's mounting surface from cosmetic damage during use**

▪ Placed between the wheel and it's mounting surface on the vehicle and may also be used between 2 dualed wheels for added protection ▪ *Wheel nuts should always be tightened to the correct torque following the wheel manufacturer's specifications*

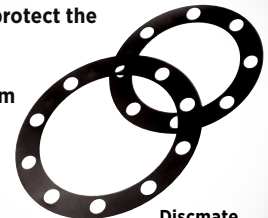

Discmate Wheel Protectors

ASCOT NO.	MFG. NO.	DESCRIPTION
402-11000	11000	10-Hole 285.75mm, Hub Pilot, 22mm Studs
402-17000	17000	10-Hole 11-1/4" Stud-Pilot, 1-1/8" Studs
402-18000	18000	10-Hole 335mm, 32mm Cap Nuts, 22mm Studs

WHEEL SERVICE PRODUCTS // WHEEL ATTACHING HARDWARE

→ Wheelok Systems for Heavy Duty Vehicles, Autos & Light Trucks

Tire & Wheel Service Tools

WHEELOK SYSTEMS FOR HEAVY DUTY VEHICLES

▪ **APPLICATION:** For trucks, tractors or trailers with spoke (Dayton) Wheels



401-10430



401-10431

ASCOT NO.	MFG. NO.	DESCRIPTION
401-10431	X10-DN43Z	Wheelok Nut & Free Spinning Sleeve - 2 Recommended For Each Wheel to Replace 2 Regular Nuts
401-10430	X10-DK43Z	Wheelok Key With Replaceable Pin - "Combination" Determined By Position Of Pins

WHEELOK SYSTEMS FOR HEAVY DUTY VEHICLES

▪ **APPLICATION:** For trucks, tractors or trailers with Budd Unimount™ Wheels - 22mm thread or equivalent



401-10220

ASCOT NO.	MFG. NO.	DESCRIPTION
401-10220	X10-UN22Z	Wheelok Nut, Flange and Free Spinning Sleeve - Combined Into One Single Unit
401-10221	X10-UK22Z	Wheelok Key with Replaceable Pin - "Combination" Determined By Position Of Pins

WHEELOK SYSTEMS FOR HEAVY DUTY VEHICLES: FRONT WHEELS

▪ **APPLICATION:** For trucks, tractors or trailers with disc (Budd) Wheels; For truck or tractor front wheels

ASCOT NO.	MFG. NO.	DESCRIPTION
401-10160	X10-BN16Z	Wheelok Nut & Free Spinning Sleeve - Right-Hand Thread - 2 For Each Wheel To Replace 2 Regular Nuts
401-10170	X10-BN17Z	Wheelok Nut & Free Spinning Sleeve - Left-Hand Thread - 2 For Each Wheel to Replace 2 Regular Nuts

WHEELOK SYSTEMS FOR HEAVY DUTY VEHICLES: REAR WHEELS

▪ **APPLICATION:** For trucks, tractors or trailers with disc (Budd) Wheels; For truck or tractor rear wheels

ASCOT NO.	MFG. NO.	DESCRIPTION
401-10280	X10-BN28Z	Wheelok Nut Only - Right Hand Thread - 2 For Each Wheel To Replace 2 Regular Nuts
401-10290	X10-BN29Z	Wheelok Nut Only - Left Hand Thread - 2 For Each Wheel To Replace 2 Regular Nuts
401-10810	X10-BK81Z	Wheelok Key With Replaceable Pin - "Combination" Determined By Position Of Pins

WHEELOK SYSTEMS FOR AUTOS & LIGHT TRUCKS

▪ **EACH KIT INCLUDES:** 4 nuts (1 for each wheel) and 1 key ▪ Available for American vehicles and imports ▪ *Combination determined by order of pins*

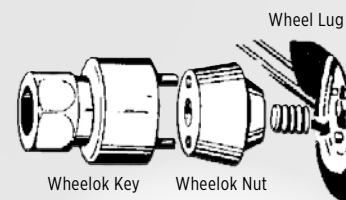
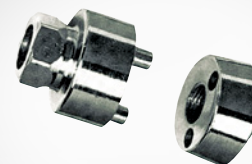
Wheel Lug
Wheelok Key Wheelok Nut

401-10000

ASCOT NO.	MFG. NO.	DESCRIPTION
401-10000	X10-SS00C	Wheelok System for autos & light trucks



➔ Rib Nut Salvage Tool Kit, Hex Nut Remover Kits, Stud Installers & Removers, Square Head Adapter, Drive-On Rib-Grip Lug-Off Kits

RIB NUT SALVAGE TOOL KIT

▪ **INCLUDES:** (1) Drift Pin, (1) Salvage Cylinder, (1) LH Thread Bolt, (1) RH Thread Bolt



499-10150

ASCOT NO.	MFG. NO.	DESCRIPTION
499-10150	X10-LS15B	Rib Nut Salvage Tool Kit

3-PIECE HEX NUT REMOVER KITS



492-15000

ASCOT NO.	MFG. NO.	DESCRIPTION
492-15000	X10-NR15B	1-1/2" Hex Nut Remover Kit - 3 Piece
492-14000	X10-NR14B	1-1/4" Hex Nut Remover Kit - 3 Piece

STUD INSTALLERS



492-10158

492-10134

ASCOT NO.	MFG. NO.	DESCRIPTION
492-10134	X10-SI34Z	For 3/4" Studs. Fits 1-3/4" Socket
492-10150	X10-LC15B	Rib Nut Salvage Cylinder
492-10158	X10-SI58Z	For 5/8" Studs. Fits 1-1/4" Socket
492-10159	X10-SI59Z	For 5/8" x 18 Studs. Fits 1-1/4" Socket
492-10196	X10-SI96Z	For 9/16" x 18 studs. Fits 1-1/4" Socket
492-10590	X10-SI59Z	5/8"- 18 Stud Installer

STUD REMOVERS

ASCOT NO.	MFG. NO.	DESCRIPTION
492-10340	X10-SR34B	For 3/4" Studs. Fits 1-3/4" Socket
492-10580	X10-SR58B	For 5/8" Studs. Fits 1-1/4" Socket
492-10180	X10-SR18B	For 1-1/8" Studs. Fits 1-1/4" Socket
492-10780	X10-SR78B	For 7/8" Studs. Fits 1-1/4" Socket

13/16" SQUARE HEAD ADAPTER

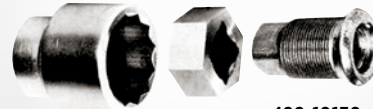

499-10130

ASCOT NO.	MFG. NO.	DESCRIPTION
499-10130	X10-SA13B	Fits 1-1/2" Socket Wrench to Speed Up Installing Or Removing Budd Wheel Inner Cap Nuts
499-10171	X10-SA17B	17mm Stud Adapter
499-10210	X10-SA21B	21mm Stud Adapter

HEAVY DUTY DRIVE-ON RIB-GRIP LUG-OFF KITS



499-10200

ASCOT NO.	MFG. NO.	DESCRIPTION
499-10200	X10-LT20B	For Removing Damaged Inner Cap Nuts (1-1/8" Dia. - 13/16" Square Head) INCLUDES: (1) Drive-On Tool And (1) Rib Nut
499-10340	X10-LT34B	For Removing Damaged 3/4" Lug Studs. INCLUDES: (1) Drive-On Tool And (1) Rib Nut
499-10580	X10-LT58B	For Removing Damaged 5/8" Lug Studs. INCLUDES: (1) Drive-On Tool, (1) Rib Nut
499-10660	X10-LT66B	Triple Duty Tool For Removing Damaged Budd Wheel Inner Cap Nuts, 3/4" And 5/8" Lug Studs. INCLUDES: (1) Drive-On Tool and (3) Rib Nuts

REPLACEMENT RIB NUTS

ASCOT NO.	MFG. NO.	DESCRIPTION
499-10180	X10-LN18B	For Budd Wheel Inner Cap Nuts
499-10341	X10-LN34B	For 3/4" Lug Studs
499-10581	X10-LN58B	For 5/8" Lug Studs
499-10211	X10-LN21B	For 21mm Lug Studs
499-11171	X10-LN17B	For 17mm Lug Studs
492-10151	X10-LP15Z	Drive Pin

Please contact us for more information regarding **Tire & Wheel Service Tools**

WHEEL SERVICE PRODUCTS // TIRE & WHEEL SERVICE TOOLS

➔ Spare Tire Tool Set, Thread Pitch Gauge, Rim Flange Wear Gauge, Chamfer/Nut Gauge

Tire & Wheel Service Tools (cont.)

7-PIECE SPARE TIRE TOOL SET

▪ Allows anyone to quickly remove difficult to reach spare tires ▪ No more digging through the customer's vehicle to locate the spare tire removal kit ▪ Color-coded wall bracket allows user to quickly identify the correct removal tool
 ▪ **APPLICATION:** Includes many trucks & SUV's where the spare tire is located under the vehicle

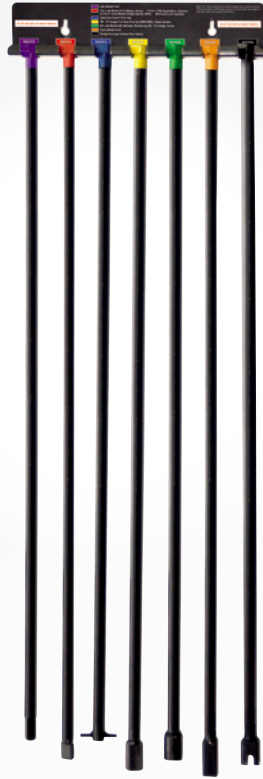

ASCOT NO.	MFG. NO.	DESCRIPTION
319-96090	96090A	7-Piece Spare Tire Tool Kit

319-96090

ASCOT NO.	MFG. NO.	DESCRIPTION
INDIVIDUAL SPARE TIRE TOOLS		
319-96091	96091	Spare Tire Tool - Flat Head: Red APPLICATION: For Use on Late Model S10 trucks, Explorers, Blazers, Jimmys, F150s, Expeditions, Older Dakota 2-Wheel Drives and McGuard Lock Systems
319-96092	96092	Spare Tire Tool - Pin Head: Blue APPLICATION: For Use on Import Trucks
319-96093	96093	Spare Tire Tool - Hex Head: Yellow APPLICATION: For Use on Dodge Full Size and Stake Bodies, '98-'01 Dodge Full-Size 4-Wheel Drive
319-96094	96094	Spare Tire Tool - 12mm Square Head: Green APPLICATION: For Use on All Late Model GMs, Remaining '98-'03 Dodge Trucks
319-96095	96095	Spare Tire Tool - Std. Square Head: Orange APPLICATION: For Use on Older Ford Trucks
319-96096	96096	Spare Tire Tool - Slotted Square Head: Black APPLICATION: For Use on Dodge Durango, Inside the Hatch
319-96097	96097	Wall Mount Bracket for Spare Tire Tool Set Color-coded to allow user to quickly identify the correct removal tool
319-96098	96098	Spare Tire Tool - 3/8" Square Head: Purple APPLICATION: For Use on New Ford Models

ALCOA RIM FLANGE WEAR GAUGE

▪ Determines if wheel must be removed from service due to excessive rim flange wear



ASCOT NO.	MFG. NO.	DESCRIPTION
401-00700	000700	Alcoa Rim Flange Wear Gauge

401-00700



UNI-MOUNT M22 THREAD PITCH GAUGE

▪ **APPLICATION:**

Designed for M22 x 1.5

Uni-Mount

Studs ▪ If the thread teeth do not fully engage the stud, the stud should be removed from service ▪ Simple to use



401-69260

ASCOT NO.	MFG. NO.	DESCRIPTION
401-69260	69260	Uni-Mount Thread Gauge



CHAMFER/NUT GAUGE

▪ **Kit shows when wheel chamfers and wheel nuts are worn out** ▪ Visual guide detects excessive wear in bolt holes

▪ **APPLICATION:** For use with steel stud piloted wheels



401-69290

ASCOT NO.	MFG. NO.	DESCRIPTION
401-69290	69290	Chamfer Nut Gauge

For Penetrants, please see Tire & Wheel Service section

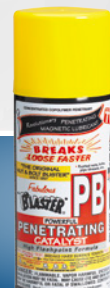

➔ Portable Truck Wheel Stud Installer & Remover, Wheel Installation Sleeves, Stud Cleaning Tools



PORTABLE TRUCK WHEEL STUD REMOVER & INSTALLER

- **Power of a 10-ton shop press**
- Remove and install studs without removing the hub
- Two-hour job is done in twenty minutes without risk of damaging seals or bearings
- Any mechanic can use it to get the job done right in minutes

POWER OF A 10-TON SHOP PRESS



492-06346

ASCOT NO.	MFG. NO.	DESCRIPTION
492-06247	6247	PakPress Cart
492-06346	6346	Complete PakPress Kit - Includes Cart



ALCOA WHEEL INSTALLATION SLEEVES

- **Align wheel bolt holes**
- Seat brake drums that have .980" diameter bolt holes
- Prevent damage to M22x1.5 studs
- Assist in lining up all components for ease of install
- **INCLUDES:** 2 tools per kit
- **Made in USA**



491-00426

ASCOT NO.	MFG. NO.	DESCRIPTION
491-00426	407422	Alcoa Wheel Installation Sleeves

Stud and Brake Hub Cleaning Tools

STUD CLEANING TOOLS

- **Allows for cleaning the full length of the thread on 10 studs in less than 3 minutes**
- Works with air or hand tools
- **CAUTION:** Always use eye protection
- 1/2" adapter included with each tool
- Replacement Brushes Available

WORKS WITH AIR OR HAND TOOLS

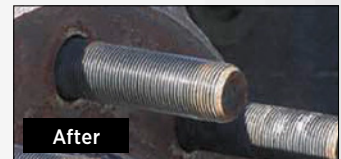

Stud Cleaning Tool in use.

ASCOT NO.	MFG. NO.	DESCRIPTION
402-00013	SBCT-13	13mm (1/2") Stud Cleaning Tool
402-00022	SBCT-22	22mm (7/8") Stud Cleaning Tool
402-00028	SBCT28	28mm (1-1/8") Stud Cleaning Tool

ASCOT NO.	MFG. NO.	DESCRIPTION
REPLACEMENT BRUSHES FOR STUD CLEANING TOOLS		
402-00112	SBR12	12mm (7/16") Repl. Brush
402-00113	SBR13	13mm (1/2") Repl. Brush
402-00014	SBR14	14mm (9/16") Repl. Brush
402-00016	SBR16	16mm (5/8") Repl. Brush
402-00118	SBR18	18mm (45/64") Repl. Brush
402-00120	SBR20	20mm (25/32") Repl. Brush
402-00122	SBR22	22mm (7/8") Repl. Brush
402-00128	SBR28	28mm (1-1/8") Repl. Brush



Replacement Brush for Stud Cleaning Tool



402-00013

402-00022

WHEEL SERVICE PRODUCTS // TIRE & WHEEL SERVICE TOOLS



➔ Stud Cleaning Kit, Hub Buddy Tool, Wheel Hub Grinder, Brake Hub Cleaning Discs

Stud and Brake Hub Cleaning Tools (cont.)

STUD CLEANING KIT



402-01322

KIT CONTENTS

SBCT22 with a SBR22 brush	2 hex keys
Safety glasses	REPLACEMENT BRUSHES: SBR 12,13,14,16, 18, 20 and 22mm
2 adapters	

ASCOT NO.	MFG. NO.	DESCRIPTION
402-01322	SKT-1322	Stud Cleaning Kit

HUB BUDDY TOOL

- **IMPACT RATED:** No need to change tools
- Complies with best practice R.I.S.T. procedure
- Removes rust, corrosion and other build-up from wheel stud, drums and tire rim
- Helps proper torque of lug nuts by removing corrosion
- A must for easy and accurate tire balancing
- **INCLUDES:** 1 Hub Buddy XL attachment and 1 cleaning disc head
- Replacement cleaning discs available in packs of 6 (Product # 402-37335)



402-37330

ASCOT NO.	MFG. NO.	DESCRIPTION	402-37335
402-37330	37330	Hub Buddy Tool	
402-37335	37335	2" Hub Buddy Tool Replacement Pads	
402-37340	37340	1-1/2" Hub Buddy Tool Replacement Pads	

WHEEL HUB GRINDER

- Special grinder for cleaning the wheel centering device as well as the attachment area between the wheel and hub
- Burned in corrosion residues are completely removed in a quick and easy process
- Actual cleaning time per hub only takes between 3-25 seconds depending upon residue thickness
- Replacement Discs Available



402-43352



402-43351

ASCOT NO.	MFG. NO.	DESCRIPTION
402-43352	433 502/M	Wheel Hub Grinder
402-43351	433 501	Grinder Replacement Discs (3 per package)



Wheel Hub Grinder in action.

3M BRAKE HUB CLEANING DISCS

- Extremely tough three-dimensional web
- Non-metallic attachment system and disc pad holder
- Roloc disc locks securely; 1/2 turn on, 1/2 turn off
- Ideal for use on right angle air tools
- **KIT CONTAINS:** 5 Scotch-Brite Roloc Brake Hub Cleaning Discs and 1 3M Brake Hub Cleaning Disc Holder



402-07547

ASCOT NO.	MFG. NO.	DESCRIPTION
402-07545	07545	3M Brake Hub Cleaning Disc Holder
402-07546	07546	3M Scotch-Brite Roloc Brake Hub Cleaning Discs - 10 Discs
402-07547	07547	3M Scotch-Brite Roloc Brake Hub Cleaning Disc Kit

WHEEL SERVICE PRODUCTS // TIRE & WHEEL SERVICE TOOLS